

THERMOLEC LTD.

Installation Instructions for *THERMO-AIR* and *THERMO-ZONE* units.

Please read instructions carefully before starting.

Mechanical Installation.

1- The air direction may be either vertical or horizontal, but when the unit is installed horizontally, the cut-out cover **must** be on top.

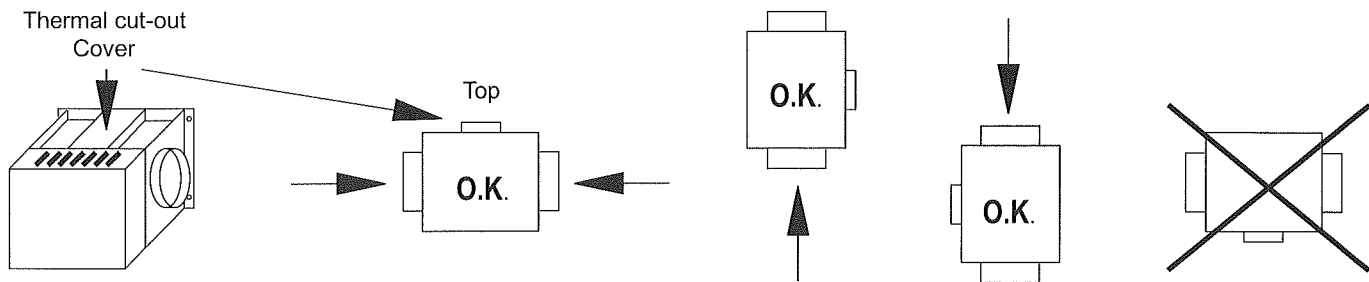

2- Do not install elbows closer than 12 inches to either the inlet or outlet of the unit.

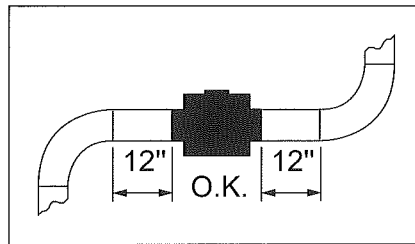

3- The electronic controller shuts down the heater when there is no air flow.

The minimum amount of air required (in cubic feet per minute) to operate the unit is given in the CFM column of the table (30 CFM per kilowatt).

If CFM is lower than specified, the airflow sensor will limit the total capacity according to the airflow available.

4- Attach the unit to a suitable support.
The 6" model is small enough to be located between standard 16" spaced floor joists.
Always allow a minimum 1/2" clearance above the heater.

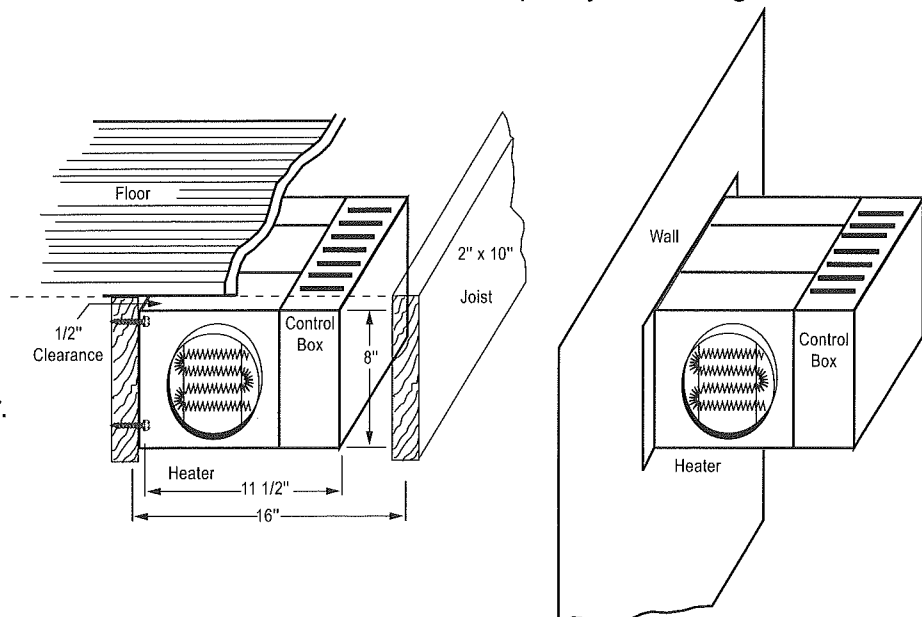

5- Electrical Installation.

Please conform to all local and national electrical codes for wiring. The heater should be supplied by a separate cable, of appropriate gauge and with appropriate protection.

Use wires suited for 75°C. Please refer to the following table Fig. 1.

Fresh Air and Zone Heaters										
Recommended wire gauge and protection										
<i>Model</i>	<i>Models</i>	<i>Collar</i>	<i>Wire</i>	<i>Min. Air Flow</i>						
					<i>SIZE</i>	<i>Dia.</i>	<i>KW</i>	<i>Volts</i>	<i>Amps.</i>	<i>Gauge</i>
TER-6-1120	& ZON-6-1120	A	6	1	120/1	8.3	12	15	30	
TER-6-1208	& ZON-6-1208	A	6	1	208/1	4.8	12	15	30	
TER-6-1240	& ZON-6-1240	A	6	1	240/1	4.2	12	15	30	
TER-6-2120	& ZON-6-2120	A	6	2	120/1	16.7	12	20	60	
TER-6-2208	& ZON-6-2208	A	6	2	208/1	9.6	12	15	60	
TER-6-2240	& ZON-6-2240	A	6	2	240/1	8.3	12	15	60	
TER-8-3208	& ZON-8-3208	B	8	3	208/1	14.4	12	20	90	
TER-8-3240	& ZON-8-3240	B	8	3	240/1	12.5	12	15	90	
TER-8-4208	& ZON-8-4208	B	8	4	208/1	19.2	10	30	120	
TER-8-4240	& ZON-8-4240	B	8	4	240/1	16.7	12	20	120	
TER-8-5208	& ZON-8-5208	B	8	5	208/1	24	10	30	150	
TER-8-5240	& ZON-8-5240	B	8	5	240/1	20.8	10	30	150	
TER-8-6240	& ZON-8-6240	B	8	6	240/1	25	10	40	180	
TER-10-3208	& ZON-10-3208	B	10	3	208/1	14.4	12	20	90	
TER-10-3240	& ZON-10-3240	B	10	3	240/1	12.5	12	15	90	
TER-10-4208	& ZON-10-4208	B	10	4	208/1	19.2	10	30	120	
TER-10-4240	& ZON-10-4240	B	10	4	240/1	16.7	12	20	120	
TER-10-5208	& ZON-10-5208	B	10	5	208/1	24	10	30	150	
TER-10-5240	& ZON-10-5240	B	10	5	240/1	20.8	10	30	150	
TER-10-6240	& ZON-10-6240	B	10	6	240/1	25	10	40	180	
TER-10-8240	N/A	C	10	8	240/1	33.3	8	50	240	
TER-10-10240	N/A	C	10	10	240/1	41.6	6	60	300	
TER-10-12240	N/A	C	10	11.5	240/1	47.9	6	60	345	
TER-12-6240	N/A	C	12	6	240/1	25	10	40	180	
TER-12-8240	N/A	C	12	8	240/1	33.3	8	50	240	
TER-12-10240	N/A	C	12	10	240/1	41.6	6	60	300	
TER-12-12240	N/A	C	12	11.5	240/1	47.9	6	60	345	

To convert Cubic Feet per Minute to liters per second,
multiply the CFM value by 0.47

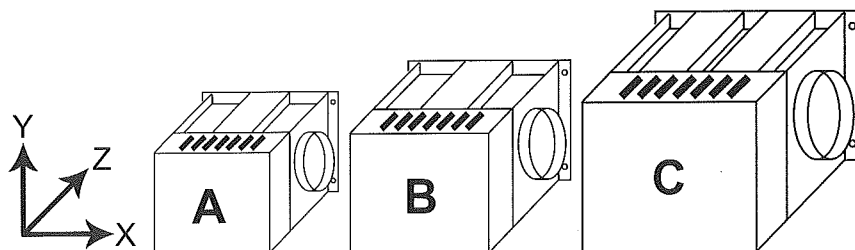

DIMENSIONS IN INCHES			
SIZE	X	Y	Z
A	11.5	8.0	11.5
B	11.5	10.0	13.5
C	15.5	12.0	15.5

6- Special Instructions for each type of unit.

THERMO-AIR (TER models in Fig. 1)

When the unit is installed and connected, set the potentiometer on the controller to the desired temperature.

Please check the air direction carefully. The temperature sensor must be located on the air outlet side. The sensor is factory installed on the left side, so the air moves from the right to the left. It has to be moved to the right if the air outlet is on the right side. A pre-punched rectangular hole is provided on the right side to accommodate this change.

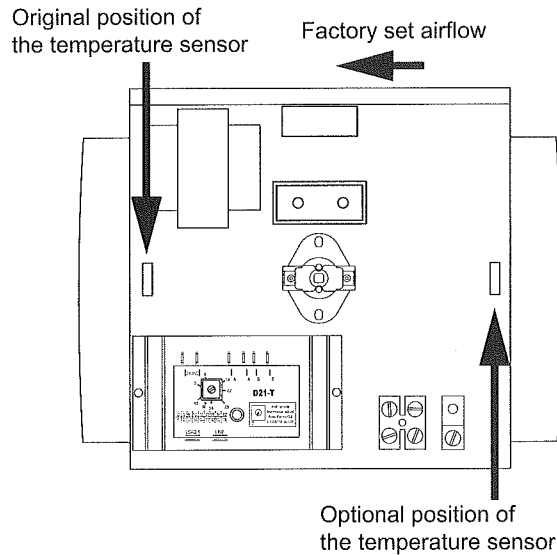

In the lower part of the table (Fig. 1) starting at SIZE C, the unit becomes bigger and the heater is split in two halves, preheat and reheat, each one supplied by its own controller and equipped with safety limits.

Following the air direction, the first half thus becomes the preheat section and the second half becomes the reheat section. The position of the sensors is very important. Please check the air direction through the heater carefully. In this model, there are three rectangular holes to allow the change of heat sensor position. Set the preheat controller to the desired output temperature and the reheat controller to 2 °C (4 °F) lower. During milder temperatures the preheat controller will be able to handle the full load without engaging the reheat controller. Please refer to the following diagrams.

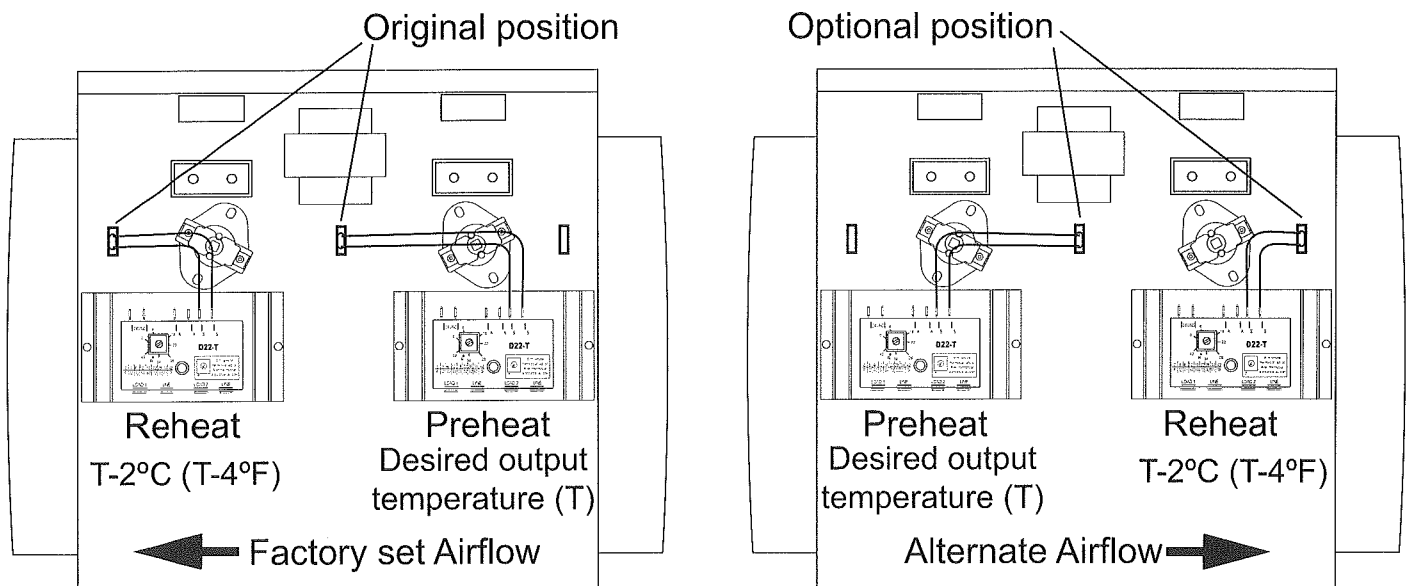

THERMO-ZONE

(ZON models in Fig. 1)

When the unit is installed and connected, set the potentiometer on the controller to “R” (remote). Install the thermostat far from a heat source, on a wall where there is no air draft. Connect the thermostat wires to the terminals marked “S S” on the controller.

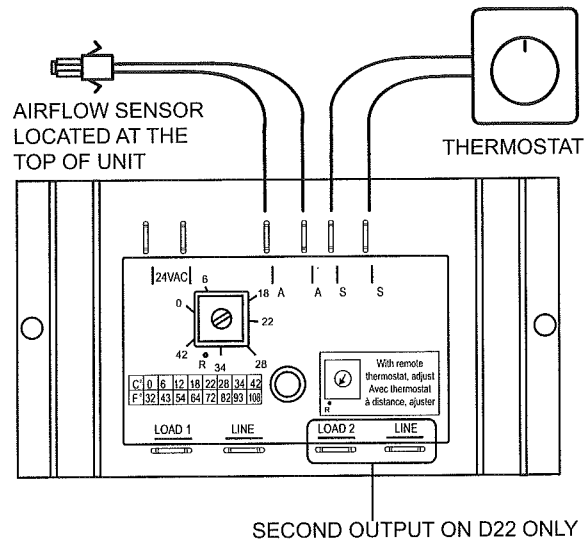

If you don't find the exact model you need in the table, please order a standard Thermolec heater equipped with SCR control.

Remember: In case of trouble or for technical assistance, please use our free Help Line:

1-800-336-9130