



**FOR
RESEARCH
AND
SPECIAL
premium
industrial
products**

WWW.CAMBRIDGERESOURCES.COM



AFFILIATE BRANDS:

zipits™



AMRAM



EXQUISITE®



**PREMIUM
QUALITY
PRODUCTS
& SERVICES**

We pledge to our customers, suppliers, and employees to continuously improve our products, processes and offerings in order to ensure that working with Cambridge™ Resources remains the most enjoyable and satisfying experience in the industry.

**INNOVATION
TOP VALUE
QUICK
TURNAROUND
COMPETITIVE
PRICING
PROFICIENT
CUSTOMER SERVICE**

ELECTRICAL ACCESSORIES

CONNECTORS

WIRE

MANAGEMENT

WIRE

STANDARD WIRE NUTS	EA5
WINGED WIRE NUTS	EA6
GROUNDING WIRE NUTS	EA6
PUSH-INS	EA7
RING TERMINALS	EA7-8
SPADE TERMINALS	EA8
FEMALE & MALE DISCONNECTS	EA9
FULLY INSULATED DISCONNECTS	EA9
BULLET & RECEPTACLE CONNECTORS	EA10
PIGGY BACK DISCONNECTS	EA10
BUTT CONNECTORS	EA11
FLAG DISCONNECTS	EA11
COPPER RING LUGS	EA11
QUICK SPLICE CONNECTORS	EA12
CLOSED-END CONNECTORS	EA12
TERMINAL TOOL	EA12
KITS	EA13-14
PRIMARY WIRE	EA15
PLASTIC CLAMPS	EA15
HEAT SHRINK	EA16
FLEX TUBING	EA16
STAPLES	EA16
ELECTRICAL TAPE	EA17

TERMINALS

ELECTRICAL ACCESSORIES

SWITCHES

PREMIUM ROCKER SWITCHES	EA18
NON-PREMIUM ROCKER SWITCHES	EA19
STARTER & SWITCH KITS	EA19
TOGGLE SWITCHES	EA20
PUSH & PULL SWITCHES	EA20
TEST LEADS	EA20

SPECIFICATIONS	EA21
TYPE I (PLASTIC - AUTO RESET)	EA22
TYPE II (METAL - MODIFIED RESET)	EA23
TYPE III (PLASTIC - MANUAL RESET)	EA24

ELECTRICAL TOOLS	EA25
------------------	------

CIRCUIT BREAKERS

TOOLS

Cambridge™ Wire Connectors, Terminals, and Wire Management are used in a wide range of applications including electrical, automotive, aerospace, home improvement, and construction.



ELECTRICAL

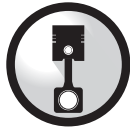

AUTOMOTIVE



AEROSPACE



HOME IMPROVEMENT



CONSTRUCTION

WIRE CONNECTORS

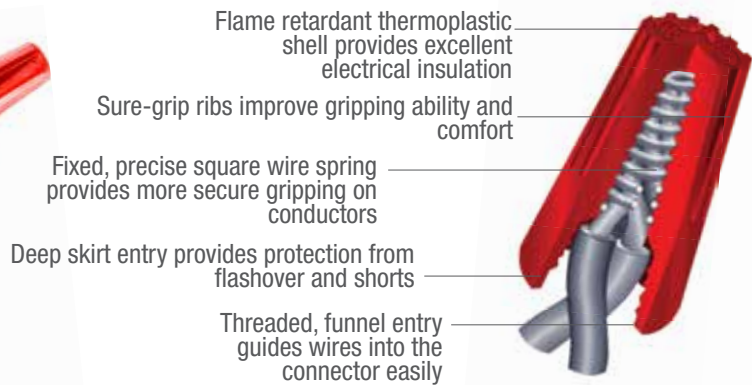

Cambridge™ Standard Wire Connectors are UL listed, CSA certified, and color-coded to industry standards.



STANDARD WIRE CONNECTORS

ITEM #	COLOR	PACKAGING	QTY	CASE QTY Total Packs	WIRE RANGE MINIMUM	WIRE RANGE MAXIMUM	VOLTAGE
WC13625	Yellow	Bag	25	10	3 #20 Sol	2 #12 w/2 #14	600
CJ-WCY	Yellow	Jar	100	20	3 #20 Sol	2 #12 w/2 #14	600
WCS-C4	Yellow	Box	100	10	3 #20 Sol	2 #12 w/2 #14	600
WCS-H4	Yellow	Bag	500	10	3 #20 Sol	2 #12 w/2 #14	600
WC13628	Orange	Bag	25	10	1 #18 w/1 #20	4 #16 w/1 #20	600
CJ-WC0	Orange	Jar	100	20	1 #18 w/1 #20	4 #16 w/1 #20	600
WCS-C3	Orange	Box	100	10	1 #18 w/1 #20	4 #16 w/1 #20	600
WCS-H3	Orange	Bag	500	10	1 #18 w/1 #20	4 #16 w/1 #20	600
CJ-WCB	Blue	Jar	100	20	2 #22	3 #16	300
WCS-C6	Blue	Box	100	10	2 #22	3 #16	300
WCS-M6	Blue	Bag	1,000	10	2 #22	3 #16	300
WCS-C8	Gray	Box	100	10	2 #22	1 #16 w/1 #18 w/1 #20	300
WCS-M8	Gray	Bag	1,000	20	2 #22	1 #16 w/1 #18 w/1 #20	300
CJ-WCR	Red	Jar	50	20	3 #18	2 #10 Sol w/2 #12 Str	600
WCS-C2	Red	Box	100	10	3 #18	2 #10 Sol w/2 #12 Str	600
WCS-H2	Red	Bag	500	10	3 #18	2 #10 Sol w/2 #12 Str	600
WC12996	Gray	Bag	3	10	2 #22	1 #16 w/1 #18 w/1 #20	300
	Blue		4		2 #22	3 #16	300
	Yellow		6		3 #20 Sol	2 #12 w/2 #14	600
	Orange		6		1 #18 w/1 #20	4 #16 w/1 #20	600
	Red		6		3 #18	2 #10 Sol w/2 #12 Str	600
T13730	Gray	Clamshell	10	120	2 #22	1 #16 w/1 #18 w/1 #20	300
	Orange		5		1 #18 w/1 #20	4 #16 w/1 #20	600
	Yellow		3		3 #20 Sol	2 #12 w/2 #14	600

WINGED WIRE CONNECTORS



Cambridge™ Winged Wire Connectors are UL listed, CSA certified, and feature the popular half-wing design. The wings act as a built-in wrench, providing maximum torque. Their narrow design makes it easy for twisting and working in tight spaces. They are color-coded to industry standards.

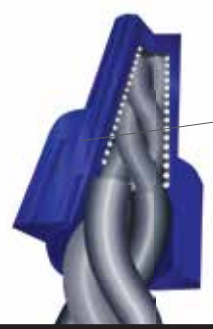

Swept-back wing design fits into your fingers naturally and provides fingertip comfort resulting in increased torquing power.

ITEM #	COLOR	PACKAGING	QTY	CASE QTY Total Packs	WIRE RANGE MINIMUM	WIRE RANGE MAXIMUM	VOLTAGE
WCW-C4	Yellow	Box	100	10	3 #18	2 #12 W/1 #14	600
WCW-H4	Yellow	Bag	500	10	3 #18	2 #12 W/1 #14	600
CJ-WWCB	Blue	Jar	25	20	2 #10 W/1 #12	3 #8 W/1 #12	600
WCW-K6	Blue	Box	50	10	2 #10 W/1 #12	3 #8 W/1 #12	600
WCW-C2	Red	Box	100	10	3 #16	5 #12 Sol	600
WCW-H2	Red	Bag	500	10	3 #16	5 #12 Sol	600
WCW-HT	Tan	Bag	500	10	3 #22 Sol	4 #12	600
WCW-CT	Tan	Box	100	10	3 #22 Sol	4 #12	600
WCW-K8	Gray	Box	50	20	3 #14 w/1 #18	3 #10	600
WCW-8-250	Gray	Bag	250	10	3 #14 w/1 #18	3 #10	600
WC13648	Yellow	Bag	8	10	3 #18	2 #12 W/1 #14	600
	Tan		7		3 #22 Sol	4 #12	600
	Red		8		3 #16	5 #12 Sol	600
	Blue		2		2 #10 W/1 #12	3 #8 W/1 #12	600



GROUNDING WIRE CONNECTORS

- Tough thermoplastic, UL 94V-2 flame-retardant shell rated for 105°C (221°F)
- Color-coded Green to industry standards for quick and easy identification
- Specifically designed for making positive ground connections and bonding non-metallic sheathed cable
- Zinc-plated square spring draws wires deep into spring for safe, tight grip and making a strong connection
- Built-in, swept-back designed wings enable user to tighten connectors easily without tools

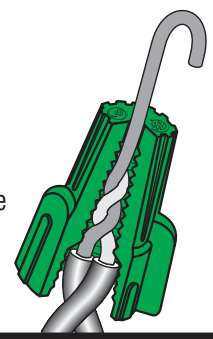

ITEM #	COLOR	PACKAGING	QTY	CASE QTY Total Packs	WIRE RANGE MINIMUM	WIRE RANGE MAXIMUM
WCW-H5	Green (Grounding)	Bag	500	10	2 #14	5 #12

PUSH-INS

- Easily slide wire into hole and push in to connect
- Stays connected without twisting or crimping

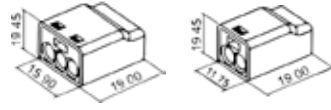

ITEM #	COLOR	PORT SIZE	BAG QTY	CASE QTY Total Bags	WIRE RANGE	VOLTAGE
WC13644	Orange	3-Port	10	120	22 - 12 AWG Sol/Str Cu	600
WC13645	Yellow	2-Port	10	120	22 - 12 AWG Sol/Str Cu	600
WC13646	Orange Yellow	3-Port 2-Port	10 10	120	22 - 12 AWG Sol/Str Cu	600
WC13647	Yellow	2-Port	20	120	22 - 12 AWG Sol/Str Cu	600

TERMINALS



TERMINALS

Cambridge's™ Terminal line covers the most commonly used electrical terminals. PVC bullet connectors and disconnects have an added copper crimp sleeve that provides a funnel entry and greater crimp security than traditional two-piece construction.



RING TERMINALS

ITEM #	AWG	SIZE SPEC	MATERIAL	QTY/PACK	PACKS/CASE	COLOR
TRP-R4-B	22-16	No. 4 Stud	PVC	1,000	10	Red
TRP-R6-B	22-16	No. 6 Stud	PVC	1,000	10	Red
TRP-R8-B	22-16	No. 8 Stud	PVC	1,000	10	Red
T13756	22-16	No. 10 Stud	PVC	21	120	Red
TRP-R10-B	22-16	No. 10 Stud	PVC	1,000	10	Red
TRP-R25-B	22-16	1/4" Stud	PVC	1,000	10	Red
TRP-R516-B	22-16	5/16" Stud	PVC	1,000	10	Red
TRP-R38-B	22-16	3/8" Stud	PVC	1,000	10	Red
TRP-B4-B	16-14	No. 4 Stud	PVC	1,000	10	Blue
T12849	16-14	No. 6 Stud	PVC	10	120	Blue
TRP-B6-B	16-14	No. 6 Stud	PVC	1,000	10	Blue
T13750	16-14	No. 8 Stud	PVC	20	120	Blue
TRP-B8-B	16-14	No. 8 Stud	PVC	1,000	10	Blue
T13740	16-14	No. 10 Stud	PVC	18	120	Blue
TRP-B10-B	16-14	No. 10 Stud	PVC	500	20	Blue
T13738	16-14	1/4" Stud	PVC	16	120	Blue
TRP-B25-B	16-14	1/4" Stud	PVC	1,000	10	Blue
TRP-B516-B	16-14	5/16" Stud	PVC	1,000	10	Blue

RING TERMINALS continued

ITEM #	AWG	SIZE SPEC	MATERIAL	QTY/PACK	PACKS/CASE	COLOR
T13747	16-14	3/8" Stud	PVC	14	120	Blue
TRP-Y6-B	12-10	No. 6 Stud	PVC	500	10	Yellow
TRP-Y8-B	12-10	No. 8 Stud	PVC	500	10	Yellow
T13744	12-10	No. 10 Stud	PVC	13	120	Yellow
T13739	12-10	1/4" Stud	PVC	11	120	Yellow
TRP-Y25-B	12-10	1/4" Stud	PVC	500	10	Yellow
T13729	12-10	5/16" Stud	PVC	11	120	Yellow
TRP-Y516-B	12-10	5/16" Stud	PVC	500	10	Yellow
T13735	12-10	3/8" Stud	PVC	11	120	Yellow
TRP-Y38-B	12-10	3/8" Stud	PVC	500	10	Yellow
TRP-Y12-B	12-10	1/2" Stud	PVC	500	10	Yellow
T12845	22-16 16-14 12-10	No. 6 Stud No. 8 Stud No. 8 Stud	PVC	8 6 4	120	Red Blue Yellow

WEATHERPROOF HEAT SHRINK RING TERMINALS

ITEM #	AWG	SIZE SPEC	MATERIAL	QTY/PACK	PACKS/CASE	COLOR
T13761	16-14	No. 10 Stud	Weatherproof	10	120	Blue
T13754	16-14	1/4" Stud	Weatherproof	10	120	Blue
T13755	12-10	1/4" Stud	Weatherproof	7	120	Yellow
T13751	12-10	3/8" Stud	Weatherproof	7	120	Yellow

SPADE TERMINALS

ITEM #	AWG	SIZE SPEC	MATERIAL	QTY/PACK	PACKS/CASE	COLOR
TSP-R4-B	22-16	No. 4 Stud	PVC	1,000	10	Red
TSP-R6-B	22-16	No. 6 Stud	PVC	1,000	10	Red
TSP-R8-B	22-16	No. 8 Stud	PVC	1,000	10	Red
TSP-R10-B	22-16	No. 10 Stud	PVC	1,000	10	Red
TSP-R25-B	22-16	1/4" Stud	PVC	1,000	10	Red
TSP-B4-B	16-14	No. 4 Stud	PVC	1,000	10	Blue
TSP-B6-B	16-14	No. 6 Stud	PVC	1,000	10	Blue
T12860	16-14	No. 8 Stud	PVC	10	120	Blue
TSP-B8-B	16-14	No. 8 Stud	PVC	1,000	10	Blue
TSP-B10-B	16-14	No. 10 Stud	PVC	1,000	10	Blue
TSP-B25-B	16-14	1/4" Stud	PVC	1,000	10	Blue
TSP-B516-B	16-14	5/16" Stud	PVC	1,000	10	Blue
TSP-Y6-B	12-10	No. 6 Stud	PVC	500	10	Yellow
TSP-Y8-B	12-10	No. 8 Stud	PVC	500	10	Yellow
T12858	12-10	No. 10 Stud	PVC	10	120	Yellow
TSP-Y10-B	12-10	No. 10 Stud	PVC	500	10	Yellow
TSP-Y25-B	12-10	1/4" Stud	PVC	500	10	Yellow
T12859	22-16 16-14 12-10	No. 8 Stud No. 8 Stud No. 8 Stud	PVC	8 7 5	120	Red Blue Yellow



MALE & FEMALE DISCONNECTS

ITEM #	AWG	SIZE SPEC Inches	MATERIAL	QTY/PACK	PACKS/CASE	COLOR
TFDP-R187-B	22-16	0.187	PVC	1,000	10	Red
TFDP-R25-B	22-16	0.25	PVC	1,000	10	Red
T13725	16-14	0.25	PVC	20	120	Blue
TFDP-B187-B	16-14	0.187	PVC	1,000	10	Blue
TFDP-B25-B	16-14	0.25	PVC	1,000	10	Blue
TFDP-Y25-B	12-10	0.25	PVC	1,000	10	Yellow
TFDP-Y375-B	12-10	0.375	PVC	1,000	10	Yellow
T12844	22-16 16-14 12-10	0.25	PVC	6 6 6	120	Red Blue Yellow
TMDP-R187-B	22-16	0.187	PVC	500	20	Red
TMDP-R25-B	22-16	0.25	PVC	500	20	Red
TMDP-B187-B	16-14	0.187	PVC	500	20	Blue
T13749	16-14	0.25	PVC	20	120	Blue
TMDP-B25-B	16-14	0.25	PVC	500	20	Blue
TMDP-Y25-B	12-10	0.25	PVC	500	20	Yellow
T13736	22-18 22-18 16-14 16-14 12-10 12-10	0.25	PVC	2 2 4 6 2 2	120	Red (M) Red (F) Blue (M) Blue (F) Yellow (M) Yellow (F)



WEATHERPROOF HEAT SHRINK FEMALE DISCONNECTS

ITEM #	AWG	SIZE SPEC Inches	MATERIAL	QTY/PACK	PACKS/CASE	COLOR
T13752	16-14	0.25	Weatherproof	10	120	Blue
T13766	12-10	0.25	Weatherproof	7	120	Yellow

FULLY INSULATED MALE & FEMALE DISCONNECTS



ITEM #	AWG	SIZE SPEC Inches	MATERIAL	QTY/PACK	PACKS/CASE	COLOR
TFDIN-R25-B	22-16	0.25	Nylon	1,000	10	Red
TFDIN-B25-B	16-14	0.25	Nylon	1,000	10	Red
TFDIN-Y25-B	12-10	0.25	Nylon	500	10	Blue
T13757	22-16	0.25	Nylon	5 (M) 5 (F)	120	Red
T13734	16-14	0.25	Nylon	5 (M) 5 (F)	120	Blue
T13753	12-10	0.25	Nylon	5 (M) 5 (F)	120	Yellow

Seamlessly connect wires to appliances and devices using Cambridge™ terminals with peace of mind knowing that each product meets or exceeds UL standards.



BULLET CONNECTORS

ITEM #	AWG	SIZE SPEC Inches	MATERIAL	QTY/PACK	PACKS/CASE	COLOR
TBCP-R156-B	22-16	0.156	PVC	1,000	10	Red
TBCP-B156-B	16-14	0.156	PVC	1,000	10	Blue

RECEPTACLE CONNECTORS

ITEM #	AWG	SIZE SPEC Inches	MATERIAL	QTY/PACK	PACKS/CASE	COLOR
TRCP-R156-B	22-16	0.156	PVC	1,000	10	Red
TRCP-B156-B	16-14	0.156	PVC	1,000	10	Blue

BULLET & RECEPTACLE CONNECTORS SET

ITEM #	AWG	SIZE SPEC Inches	MATERIAL	QTY/PACK	PACKS/CASE	COLOR
T14352	22-18	0.156	PVC	5 Bullet 5 Receptacle	120	Red
T13746	16-14	0.156	PVC	10 Bullet 10 Receptacle	120	Blue
T12865	16-14	0.156	PVC	5 Bullet 5 Receptacle	120	Blue
T12866	12-10	0.156	PVC	5 Bullet 5 Receptacle	120	Yellow

PIGGY BACK DISCONNECTS

ITEM #	AWG	SIZE SPEC Inches	MATERIAL	QTY/PACK	PACKS/CASE	COLOR
TPBP-R25-B	22-16	0.25	PVC	1,000	10	Red
TPBP-B25-B	16-14	0.25	PVC	1,000	10	Blue
TPBP-Y25-B	12-10	0.25	PVC	500	10	Yellow

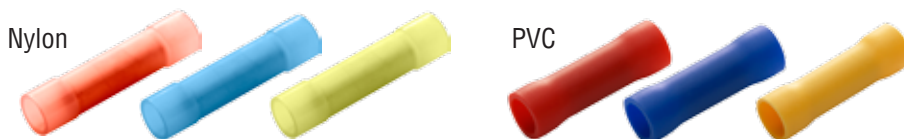

BUTT CONNECTORS

ITEM #	AWG	MATERIAL	QTY/PACK	PACKS/CASE	COLOR
T13722	22-18	PVC	21	120	Red
T12833	22-18	PVC	100	120	Red
TBP-R-B	22-16	PVC	1,000	10	Red
T13723	16-14	PVC	21	120	Blue
T12835	16-14	PVC	100	120	Blue
TBP-B-B	16-14	PVC	1,000	10	Blue
T13732	12-10	PVC	13	120	Yellow
T12837	12-10	PVC	50	120	Yellow
TBP-Y-B	12-10	PVC	500	10	Yellow
T13733	22-16 16-14 12-10	PVC	7 5 4	120	Red Blue Yellow
TBN-R-B	22-16	Nylon	1,000	10	Red
TBN-B-B	16-14	Nylon	1,000	10	Blue
TBN-Y-B	12-10	Nylon	500	10	Yellow

WEATHERPROOF HEAT SHRINK BUTT CONNECTORS



ITEM #	AWG	MATERIAL	QTY/PACK	PACKS/CASE	COLOR
T13727	22-18	Weatherproof	10	120	Red
T13724	16-14	Weatherproof	10	120	Blue
T13737	12-10	Weatherproof	7	120	Yellow

FLAG DISCONNECTS

ITEM #	AWG	MATERIAL	QTY/PACK	PACKS/CASE	COLOR
TFLDN-R-B	22-18	Nylon	1,000	10	Red
TFLDN-B-B	16-14	Nylon	1,000	10	Blue

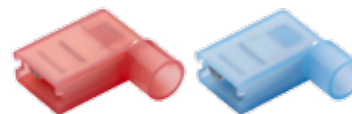

COPPER RING LUGS

ITEM #	SIZE SPEC Inches	MATERIAL	QTY/PACK	PACKS/CASE
T11738	3/8	Copper	1	120
T13726	3/8	Copper	2	120
T13768	1/4	Copper	6	120
T13767	3/8	Copper	6	120





QUICK SPLICE CONNECTORS

ITEM #	AWG	MATERIAL	QTY/PACK	PACKS/CASE	COLOR
T12862	22-16	PVC	5	10	Red
TQS-R-B	22-16	PVC	1,000	10	Red
T13728	18-14	PVC	7	120	Blue
T13731	18-14	PVC	25	60	Blue
TQS-B-B	16-14	PVC	1,000	10	Blue
T12863	12-10	PVC	4	10	Yellow
TQS-Y-B	12-10	PVC	1,000	5	Yellow
T13745	22-16 18-14 12-10	PVC	6 12 3	60	Red Blue Yellow

WEATHERPROOF QUICK SPLICE CONNECTORS

ITEM #	AWG	MATERIAL	QTY/PACK	PACKS/ CASE	COLOR
T13742	18-14	Weatherproof	4	120	Blue



CLOSED-END CONNECTORS

ITEM #	AWG	MATERIAL	QTY/PACK	PACKS/CASE	COLOR
TWCN-2214C-B	22-14	Copper / Nylon	1,000	10	White
TWCN-2212C-B	22-12	Copper / Nylon	1,000	10	White
TWCN-1610C-B	16-10	Copper / Nylon	500	10	White



TERMINAL TOOL CCT-01A

- Made from heat-treated No. 45 cold-rolled steel for long life and accuracy
- Cushioned grip insulated handles
- Heavy Duty, but lightweight (weighs only 7oz)
- Up-front crimping dies (for 26-10 insulated terminals) are color-coded for size
- Easy-to-read engraved marking

TERMINAL KITS / ASSORTMENTS



T12847

- 9 Red Ring Terminals 22-16 AWG #10
- 10 Blue Ring Terminals 16-14 AWG #10
- 5 Yellow Ring Terminals 12-10 AWG #10
- 10 Blue Spade Terminals 16-14 AWG #10
- 5 Yellow Spade Terminals 12-10 AWG #10
- 9 Red Butt Connectors 22-16 AWG
- 9 Blue Butt Connectors 16-14 AWG
- 5 Yellow Butt Connectors 12-10 AWG
- 9 Red Female Disconnects 22-16 AWG .25"
- 10 Blue Female Disconnect 16-14 AWG .25"
- 9 Red Male Disconnects 22-16 AWG .25"
- 10 Blue Male Disconnects 16-14 AWG .25"



T12846

- 3 Red Ring Terminals 22-16 AWG #8
- 4 Blue Ring Terminals 16-14 AWG #10
- 3 Blue Ring Terminals 16-14 AWG #8
- 5 Red Spade Terminals 22-16 AWG #8
- 3 Yellow Spade Terminals 12-10 AWG #10
- 5 Red Butt Connectors 22-16 AWG
- 4 Blue Butt Connectors 16-14 AWG
- 3 Yellow Butt Connectors 12-10 AWG
- 5 Red Female Disconnects 22-16 AWG .25"
- 5 Blue Female Disconnects 16-14 AWG .25"



T12867

- 5 Yellow Spade Terminals 12-10 AWG #10
- 5 Yellow Butt Connectors 12-10 AWG
- 5 Yellow Ring Terminals 12-10 AWG #10
- 10 Blue Spade Terminals 16-14 AWG #10
- 10 Blue Butt Connectors 16-14 AWG
- 10 Blue Male Disconnects 16-14 AWG 1/4"
- 10 Blue Ring Terminals 16-14 AWG #10
- 10 Blue Ring Terminals 16-14 AWG #8
- 15 Blue Ring Terminals 16-14 AWG #4
- 10 Blue Female Disconnects 16-14 AWG 1/4"
- 10 Red Male Disconnects 22-18 AWG 1/4"
- 10 Red Female Disconnects 22-18 AWG 1/4"
- 10 Red Spade Terminals 22-18 AWG
- 10 Red Butt Connectors 22-18 AWG
- 10 Red Spade Terminals 22-18 AWG #4
- 10 Red Ring Terminals 22-18 AWG #10
- 10 Red Ring Terminals 22-18 AWG #8
- 15 Red Ring Terminals 22-18 AWG #6
- 1 Carrying Case

T13765

- 8 Yellow Ring Terminals 12-10 AWG 1/4"
- 8 Blue Ring Terminals 16-14 AWG #10
- 8 Blue Ring Terminals 16-14 AWG 1/4"
- 8 Yellow Ring Terminals 12-10 AWG #10
- 8 Red Ring Terminals 22-18 AWG #10
- 10 Blue Ring Terminals 16-14 AWG #6
- 4 Yellow Spade Terminals 12-10 AWG #10
- 8 Blue Spade Terminals 16-14 AWG #10
- 2 Red Spade Terminals 22-18 AWG #10
- 6 Blue Butt Connectors 16-14 AWG
- 6 Red Butt Connectors 22-18 AWG
- 8 Blue Male Disconnects 16-14 AWG 1/4"
- 4 Red Male Disconnects 22-18 AWG 1/4"
- 8 Blue Female Disconnects 16-14 AWG 1/4"
- 4 Red Female Disconnects 22-18 AWG 1/4"
- 1 Crimper/Stripper Tool



CTK-180

- 10 Red Ring Terminals 22-18 AWG #6
- 10 Red Ring Terminals 22-18 AWG #8
- 10 Red Ring Terminals 22-18 AWG #10
- 10 Blue Ring Terminals 16-14 AWG #6
- 10 Blue Ring Terminals 16-14 AWG #8
- 10 Blue Ring Terminals 16-14 AWG #10
- 5 Yellow Ring Terminals 12-10 AWG #10
- 10 Red Spade Terminals 22-18 AWG #8
- 10 Red Spade Terminals 22-18 AWG #10
- 10 Blue Spade Terminals 16-14 AWG #8
- 10 Blue Spade Terminals 16-14 AWG #10
- 5 Yellow Spade Terminals 12-10 AWG #10
- 10 Red Butt Connectors 22-18 AWG
- 10 Blue Butt Connectors 16-14 AWG
- 10 Yellow Butt Connectors 12-10 AWG
- 10 Red Male Disconnects 22-18 AWG .25"
- 10 Blue Male Disconnects 16-14 AWG .25"
- 10 Red Female Disconnects 22-18 AWG .25"
- 10 Blue Female Disconnects 16-14 AWG .25"
- 1 8" Crimping tool

T12848

- 3 Red Ring Terminals 22-18 AWG #6
- 3 Blue Ring Terminals 16-14 AWG #10
- 3 Red Spade Terminals 22-18 AWG #8
- 3 Blue Spade Terminals 16-14 AWG #10
- 3 Red Butt Connectors 22-18 AWG
- 3 Blue Butt Connectors 16-14 AWG
- 3 Red Female Disconnects 22-18 AWG .25"
- 3 Blue Female Disconnects 16-14 AWG .25"
- 1 8" Crimping Tool



T14352

- 4 Yellow Male Disconnects 12-10 AWG Vinyl .25"
- 4 Yellow Female Disconnects 12-10 AWG Vinyl .25"
- 4 Yellow Female Disconnects 12-10 AWG Nylon .25"
- 4 Yellow Butt Connectors 12-10 AWG
- 4 Yellow Spade Terminals 12-10 AWG #8
- 4 Yellow Spade Terminals 12-10 AWG #10
- 4 Yellow Ring Terminals 12-10 AWG 3/8"
- 4 Yellow Ring Terminals 12-10 AWG 5/16"
- 4 Yellow Ring Terminals 12-10 AWG 1/4"



TERMINAL KITS / ASSORTMENTS (Cont.)

Cambridge™ Terminal Kits are assembled with the professional electrician and custom DIY'er in mind. Each terminal kit contains premium quality terminals composed of either PVC or Nylon. They come in a durable, reusable plastic case that keeps them organized and neat. Our Electrical Repair kits come with the wire and tools electricians need to get the job done. Each kit is optimized for quality, reliability, and affordability in one complete package.

CTK-510

- 40 Red Ring Terminals 22-18 AWG #6
- 40 Red Ring Terminals 22-18 AWG #10
- 30 Blue Ring Terminals 16-14 AWG #6
- 30 Blue Ring Terminals 16-14 AWG #10
- 20 Yellow Ring Terminals 12-10 AWG #8
- 20 Yellow Ring Terminals 12-10 AWG .25"
- 40 Red Spade Terminals 22-18 AWG #6
- 40 Red Spade Terminals 22-18 AWG #10
- 25 Blue Spade Terminals 16-14 AWG #6

- 25 Blue Spade Terminals 16-14 AWG #10
- 15 Yellow Spade Terminals 12-10 AWG #8
- 15 Yellow Spade Terminals 12-10 AWG .25"
- 35 Red Butt Connectors 22-18 AWG
- 25 Blue Butt Connectors 16-14 AWG
- 15 Yellow Butt Connectors 12-10 AWG
- 40 Red Female Disconnects 22-18 AWG .25"
- 35 Blue Female Disconnects 16-14 AWG .25"
- 20 Yellow Female Disconnects 12-10 AWG .25"



Double-Sided Case



ELECTRICAL REPAIR KIT

KIT DE REPARACIÓN ELÉCTRICOS



Contents listed on back

399 PCS

ELECTRICAL TOOLS & ACCESSORIES

Herramientas y Accesorios Eléctricos

repair. rewire. restore.

T13762

- 5 Red Ring Terminals 22-18 AWG #8
- 5 Blue Ring Terminals 16-14 AWG #10
- 4 Yellow Ring Terminals 12-10 AWG #10
- 5 Red Male Disconnects 22-18 AWG .25"
- 5 Red Female Disconnects 22-18 AWG .25"
- 5 Blue Male Disconnect 16-14 AWG .25"
- 5 Blue Female Disconnects 16-14 AWG .25"
- 5 Red Spade Terminals 22-18 AWG #8
- 5 Blue Spade Terminals 16-14 AWG #8
- 4 Yellow Spade Terminals 12-10 AWG #10
- 8 Blue Quick Splice Connectors 16-14 AWG
- 14 Red Butt Connectors 22-18 AWG
- 14 Blue Butt Connectors 16-14 AWG
- 10 Gray Standard Wire Connectors 22-14
- 10 Blue Standard Wire Connectors 22-14
- 10 Orange Standard Wire Connectors 22-14

- 250 4" Natural/Black/Red/Yellow/Green Mini Cable Ties 18lb
- 6 8" Natural Mini Cable Ties 18lb
- 4 6" Black/Blue/Green/Yellow Hook & Loop Ties
- 1 Crimping Tool
- 1 Insulated shaft screwdriver straight blade
- 1 Insulated shaft screwdriver Phillips
- 1 6" Long nose pliers/cutter
- 1 6-12 volts DC circuit tester
- 1 Fuse puller
- 1 30" Red & Black Test leads; 20 Gauge
- 1 60" Red insulated wire 18 Gauge
- 9 Wire Clamps 1/8"
- 3 Wire clamps 1/4"
- 3 Wire Clamps 3/8"
- 1 Roll black Tape 3/4" x 30ft



ELECTRICAL REPAIR KIT

KIT DE REPARACIÓN ELÉCTRICOS



Contents listed on back

208 PCS

repair. rewire. restore.

T13763

- 15 Red Ring Terminals 22-18 AWG #8
- 8 Blue Ring Terminals 16-14 AWG #10
- 3 Yellow Ring Terminals 12-10 AWG #10
- 2 Yellow Ring Terminals 12-10 AWG 3/8"
- 4 Blue Ring Terminals 16-14 AWG 1/4"
- 4 Blue Ring Terminals 16-14 AWG 5/16"
- 16 Blue Female Disconnects 16-14 AWG 1/4"
- 8 Blue Spade Terminals 16-14 AWG #10
- 7 Blue Quick Splice Connectors 16-14 AWG
- 8 Red Butt Connectors 22-18 AWG
- 8 Blue Butt Connectors 16-14 AWG
- 5 Yellow Butt Connectors 12-10 AWG
- 5 Closed-End Connectors 22-14 AWG
- 5 Closed-End Connectors 22-12 AWG
- 3 Blue Fully Insulated Male Quick Disconnects 16-14 AWG 1/4"
- 3 Blue Fully Insulated Female Quick Disconnects 16-14 AWG 1/4"
- 5 Standard Blue Wire Connectors 22-14
- 5 Standard Orange Wire Connectors 22-14

- 10 8" Natural Intermediate Cable Ties 40lb
- 10 6" Natural Standard Cable Ties 50lb
- 6 Black Heat Shrink Tubing .2"
- 5 Red Heat Shrink Tubing .12"

- 10 Black Grommets 1/8"
- 5 Black Grommets 3/16"
- 5 Black Grommets 1/4"

- 1 Fuse Puller
- 1 Battery Brush
- 1 Crimper Tool
- 1 Phillips Screwdriver
- 1 Flathead Screwdriver
- 1 Voltage Tester
- 1 24" Automotive Wire
- 1 Black Electrical Tape 3/4" x 30 ft
- 1 30" Test Leads (Pair)
- 10 Natural Cable Clamps 1/8"
- 3 Natural Cable Clamps 1/4"
- 3 Natural Cable Clamps 3/8"
- 1 Reusable Case

- 30 4" Natural Mini Cable Ties 18lb

Cambridge™ Wire Management products are used in a wide range of applications including:



WIRE MANAGEMENT

Cambridge™ Wire Management products are the latest and most practical products being used in the Electrical, Construction, Automotive, and Home Improvement Industries. They are affordable while maintaining the Cambridge™ standard of high quality and dependability.

PRIMARY WIRE

Cambridge™ Primary Wire comes in a broad range of sizes, gauges, and colors, and are available in conveniently packaged, easy-to-use spools. Cambridge™ Primary Wire is made from high-quality materials that ensure durability and strength.



ITEM #	GAUGE	LENGTH Feet	COLOR	PACKAGING	CASE QTY
W13794	14	20	Red	Blister	24
W13800	14	100	Red	Spool	12
W13799	12	100	Red	Spool	12
W13789	14	20	Black	Blister	24
W13797	14	100	Black	Spool	12
W13796	12	100	Black	Spool	12
W13790	18	40	Black	Blister	24
W13795	18	40	Red	Blister	24
W13792	10	8	Red	Blister	24
W13798	16	100	Black	Spool	12
W13801	16	100	Red	Spool	12
W13787	10	8	Black	Blister	24

PLASTIC CLAMPS

Cambridge™ Plastic Cable Clamps are durable, yet lightweight and easy to install. They are used in maintenance and construction to secure harnesses, cables, and tubing.



ITEM #	SIZE Inches	COLOR	PACKAGE QTY	CASE QTY
WM12880	1/4	Black	18	120
WM12881	1/4	White	18	120
WM12882	1/2	White	12	120
WM12883	3/8	White	15	120

HEAT SHRINK TUBING



ITEM #	LENGTH Inches	COLOR	DIAMETER Inches	RATIO	VOLTAGE	BAG QTY	CASE QTY Total Bags
WM12875	4	Black	1/4	2:1	600	8	120
WM12876	4	Black	1/8	2:1	600	10	120
WM12877	5	Red Blue Yellow Blue	1/8 7/32 9/32 17/32	2:1	600	3 2 1 1	120
WM13780	5-3/4 5-3/4 5 5-3/4 5	Black	1/2 3/8 5/32 1/4 3/16	2:1	600	1/ea	120



FLEX TUBING

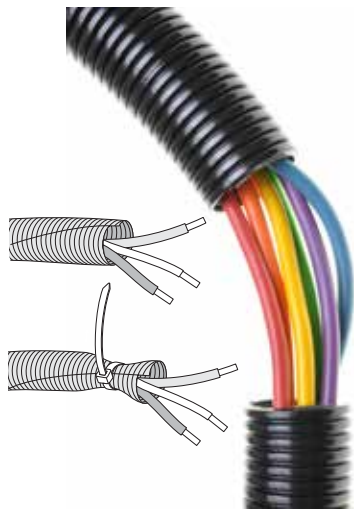

ITEM #	COLOR	DIAMETER Inches	LENGTH Feet	BAG QTY	CASE QTY Total Bags
WM12878	Black	3/8	7	1+7 zipits™	120
WM12879	Black	1/2	7	1+7 zipits™	120
WM13777	Black	3/8	5	1	12
WM13779	Black	3/4	3	1	12



Cut tubing to desired length, then gently pry tubing over completed wiring job. The pre-cut opening snaps shut to form a continuous protective cover. Fasten a zipit around the tubing for an even more secure hold.

STAPLES

ITEM #	SIZE Inches	AWG	MATERIAL	COLOR	PACKAGING	QTY	CASE QTY
ST12902	1/2	14/2, 12/2, 10/2	Plastic	White	Bag	50	10
ST12994	1/2	14/2, 12/2, 10/2	Metal	Metal	Clamshell	50	6

Cambridge™ Staples are designed to organize 14/2, 12/2, 10/2 cable wires and hold them securely in place. Easily insert the Staples into wood without causing the wood to split. Plastic and Zinc-plated nails resist rust and corrosion caused by extreme weather.

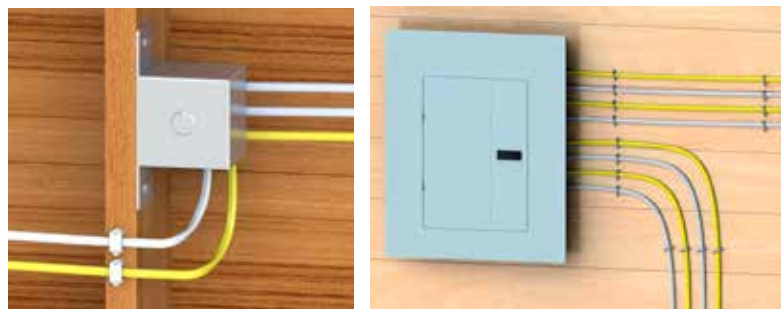

ELECTRICAL TAPE

Cambridge™ Electrical Tape provides superior adhesion while insulating and protecting. It is easy to use and is preferred by many industry leaders. Cambridge™ Electrical Tape comes in a variety of colors, lengths, and sizes. It offers an excellent value without sacrificing quality or durability.



ITEM #	WIDTH Inches	LENGTH	TYPE	COLOR	QTY	CASE QTY
ET12885	1/2	20 ft (ea)	Vinyl	Red, Blue, Yellow, Green, White	5	12
CET-0160BLK	3/4	60 ft	Vinyl	Black	1	10
CET-01BLK	3/4	66 ft	Vinyl	Black	1	6
CET-01YLW	3/4	66 ft	Vinyl	Yellow	1	6
CET-01WHT	3/4	66 ft	Vinyl	White	1	6
CET-01RED	3/4	66 ft	Vinyl	Red	1	6
CET-01ORG	3/4	66 ft	Vinyl	Orange	1	6
CET-01BLU	3/4	66 ft	Vinyl	Blue	1	6
CET-01GRN	3/4	66 ft	Vinyl	Green	1	6
CET-01BRN	3/4	66 ft	Vinyl	Brown	1	6
CET-01GRY	3/4	66 ft	Vinyl	Gray	1	6
CET-01PUR	3/4	66 ft	Vinyl	Purple	1	6
ET13709	3/4	30 ft	Vinyl	Black	1	6
ET13710	N/A	4 oz	Liquid	Black	1	12

Cambridge™ Liquid Tape adheres to all metal, plastic, vinyl, rubber, and composite surfaces. It seals loose terminal connections caused by vibration and normal wear, and forms a protective dielectric coating over connections in order to seal out moisture and prevent corrosion. It is great for use on boats, RV's, automotive applications, exposed wiring, lighting fixtures, bilge pumps, timers, and any connection requiring a waterproof seal.

Cambridge™ Electrical Tape products are UL and CSA Certified for consumer confidence, adding peace of mind to safety and quality concerns.

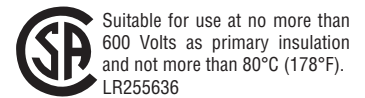

Cambridge Switches are used in a wide range of applications including:



ELECTRICAL



AUTOMOTIVE



RECREATION



HOME IMPROVEMENT



CONSTRUCTION

SWITCHES

PREMIUM ROCKER SWITCHES



ITEM #	STYLE	SPECS	CASE QTY
RS12619	Black Non-Illuminated SPST ON-OFF Rocker Switch	20A @ 12V DC / IP66 & IP68	20
RS12620	Black w/ Red LED Illuminated SPST ON-OFF Rocker Switch	20A @ 12V DC / IP66 & IP68	20
RS12621	Black w/ Blue LED Illuminated SPST ON-OFF Rocker Switch	20A @ 12V DC / IP66 & IP68	20
RS12622	Black w/ Green LED Illuminated SPST ON-OFF Rocker Switch	20A @ 12V DC / IP66 & IP68	20
RS12623	Black w/ Amber LED Illuminated SPST ON-OFF Rocker Switch	20A @ 12V DC / IP66 & IP68	20
RS12624	White w/ Red LED Illuminated SPST ON-OFF Rocker Switch	20A @ 12V DC / IP66 & IP68	20
RS12625	White w/ Blue LED Illuminated SPST ON-OFF Rocker Switch	20A @ 12V DC / IP66 & IP68	20
RS12626	White w/ Green LED Illuminated SPST ON-OFF Rocker Switch	20A @ 12V DC / IP66 & IP68	20
RS12627	White w/ Amber LED Illuminated SPST ON-OFF Rocker Switch	20A @ 12V DC / IP66 & IP68	20
RS12628	Red w/ Red LED Illuminated SPST ON-OFF Rocker Switch	20A @ 12V DC / IP66 & IP68	20
RS12629	Black Non-Illuminated SPST Momentary (ON)-OFF Rocker Switch	20A @ 12V DC / IP66 & IP68	20
RS12630	Red Non-Illuminated SPST Momentary (ON)-OFF Rocker Switch	20A @ 12V DC / IP66 & IP68	20
RS12631	Black w/ Red LED Illuminated SPDT ON-OFF-ON Rocker Switch	20A @ 12V DC / IP66 & IP68	20
RS12632	Black w/ Blue LED Illuminated SPDT ON-OFF-ON Rocker Switch	20A @ 12V DC / IP66 & IP68	20
RS12633	Black w/ Green LED Illuminated SPDT ON-OFF-ON Rocker Switch	20A @ 12V DC / IP66 & IP68	20
RS12634	Black w/ Amber LED Illuminated SPDT ON-OFF-ON Rocker Switch	20A @ 12V DC / IP66 & IP68	20
RS12635	Black Non-Illuminated DPDT Momentary (ON)-OFF-(ON) Rocker Switch	20A @ 12V DC / IP66 & IP68	20
RS12636	White Non-Illuminated DPDT Momentary (ON)-OFF-(ON) Rocker Switch	20A @ 12V DC / IP66 & IP68	20
RS12637	Black Non-Illuminated DPDT ON-ON Rocker Switch	20A @ 12V DC / IP66 & IP68	20
RS12638	Black w/ Red LED Illuminated DPDT ON-ON Rocker Switch	20A @ 12V DC / IP66 & IP68	20
RS12639	Black w/ Blue LED Illuminated DPDT ON-ON Rocker Switch	20A @ 12V DC / IP66 & IP68	20
RS12640	Black w/ Green LED Illuminated DPDT ON-ON Rocker Switch	20A @ 12V DC / IP66 & IP68	20
RS12641	Black w/ Amber LED Illuminated DPDT ON-ON Rocker Switch	20A @ 12V DC / IP66 & IP68	20
RS12642	Single Rocker Switch Mounting Panel	1.5" W x 2.5" H/Hole Size: 1" x 2"	20
RS12643	End Rocker Switch Mounting Panel	1.2" W x 2.4" H/Hole Size: 1" x 2"	20
RS12644	Center Rocker Switch Mounting Panel	1.2" W x 2.4" H/Hole Size: 1" x 2"	20
RS12645	Individual Rocker Switch Decal Labels	2.125"W x 2.5"H/3 Sheets-96 Decals	20

FEATURES:

Insulated Interior Wiring
Printed Circuit Board



Silver Dip Plated Copper Rivet for Thicker Contact Plates



Larger Saddle Position for Rocker Contact

ROCKER SWITCHES

ITEM #	DESCRIPTION	SPECS	CASE QTY
SW11736	Black Oblong Rocker Switch with Red Glow	20A, 12VDC, 240W	120
SW12933	Black Rectangular Rocker Switch with Red Glow (ON-OFF)	20A, 12VDC, 240W	120
SW12941	Black Oblong Rocker Switch with Red LED (ON-OFF)	30A, 12VDC, 360W	120
SW13870	Black Oblong Rocker Switch with Blue LED	30A, 12VDC, 360W	120



STARTERS & SWITCH KITS

ITEM #	DESCRIPTION	SPECS	CASE QTY
SW13774	1 5-Pin 30 Amp 12 Volt Relay , 7 Wires, 1 Switch & Panel, 3 Screws, 1 Quick Splice Connector	N/A	12
SW12919	Push Button Starter Switch (Momentary On)	20A, 12VDC, 180W	120
SW12943	Battery Isolater Switch	300A, 12VDC	120
SW12920	Universal Starter Switch With Keys	15A, 12VDC, 180W	60



Cambridge™ offers a wide variety of Switches, each of which can be used in many different industries including Automotive, Marine, and Aerospace. Cambridge™ Switches are available in a wide array of sizes and configurations.



SWITCHES NON-PREMIUM ROCKER / STARTERS / KITS

TOGGLE SWITCHES

ITEM #	DESCRIPTION	SPECS	CASE QTY
SW11737	Plastic Toggle Switch Red Glow (On-Off)	20A, 12VDC, 240W	120
SW12925	Pre-Wired Metal Toggle Switch (On-Off)	6A, 12VDC, 72W	120
SW12929	Metal Toggle Switch (On-Off-On) with Screw Terminals	15A, 12VDC, 180W	120
SW13880	Metal Toggle Switch (On-Off)	20A, 12VDC, 240 W	120
SW12921	Brass Toggle Switch (On-Off)	20A, 12VDC, 240W	120
SW12924	Metal Toggle Switch (On-Off)	15A, 12VDC, 180W	120
SW13776	Chrome Toggle Switch (On-Off)	35A, 12VDC, 420W	120
SW12932	Chrome Toggle Switch (On-Off-On)	35A, 12VDC, 420W	120
SW12945	Metal Lever Switch with Red LED (On-Off)	30A, 12VDC, 360W	120
SW12949	Metal Lever Switch with Green LED (On-Off)	30A, 12VDC, 360W	120
SW12951	Weatherproof Toggle with Interchangeable Boots (On-Off)	35A, 12VDC, 420W	120



PUSH & PULL SWITCHES

ITEM #	DESCRIPTION	SPECS	CASE QTY
SW12958	Fused Push-Pull Headlight Switch (On-Off)	15A, 12VDC, 180W	60
SW13771	Flush-Mount Horn Button	5A, 12VDC, 60W	120
SW13772	Push Pull Switch (On-Off)	75A, 12VDC, 900W	120
SW12923	Brass Push-Button Starter Switch (Momentary On)	15A, 12VDC, 180W	120
SW12926	Sealed Push-Button Starter Switch	60A, 12VDC, 720W	120
SW12935	Metal Push-Pull Switch (On-Off)	16A, 12VDC, 192W	60



TEST LEADS

ITEM #	DESCRIPTION	SPECS	CASE QTY
SW13705	Steel Alligator Test Clips w/ Screw	Max Amp: 1.5	120
SW13706	Steel Test Leads with Alligator Clips	22GA - 30" Length - Max Amp: 1.5	120
SW13707	Insulated Clamps	Black & Red Handles - 30AMP	60



Cambridge™ offers a wide variety of Single Pole Thermal Type Circuit Breakers in plastic or metal housings; with or without brackets; and with AMP ratings ranging from 5AMP - 50AMP. Their usage is common in automotive circuitry, power outlet strips, trolling motors, portable generators, and welding equipment.

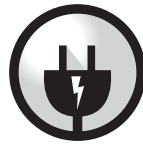

ELECTRICAL

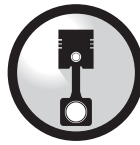

AUTOMOTIVE



RECREATION

CIRCUIT BREAKERS

INFO & SPECS

CIRCUIT BREAKER KEY

1	1	2	A	0	5	-	B	5	P
Type+Voltage	Terminal	Rating	Bracket	Mounting Holes	Cover*				
112: Type I, 12VDC 212: Type II, 12VDC 312: Type III, 24VDC 124: Type I, 24VDC 224: Type II, 24VDC	A: Two 10-32 studs; .66 (Aux), .56 (Bat) B: Two 10-32 studs; .56 (Aux & Bat) C: Two 10-32 studs; .66 (Aux & Bat) D: Two .25 QC; (Aux & Bat)*** H: One 10-32 stud; .56 (Bat), Double .25 QC (Aux)** L: Two 10-32 studs; .37 (Aux & Bat)	05 - 5 amps 08 - 8 amps 10 - 10 amps 12 - 12 amps 15 - 15 amps 20 - 20 amps 25 - 25 amps 30 - 30 amps 35 - 35 amps 40 - 40 amps 50 - 50 amps	0 - No Bracket A - Bracket B - Bracket C - Bracket E - Bracket (Plastic Only)	0 - No Bracket 1 - 0.140 ø 2 - 0.196 ø 3 - 0.237 ø (Metal only) 4 - 0.265 ø (Plastic only) 5 - 0.228 ø (Plastic only) 6 - 0.221 ø (Metal only)	M - Metal* P - Plastic*				

Two nuts included with each circuit breaker
*Series 312 available in plastic cover only. Series 212 & 224 available in metal cover only.
**40A maximum
***30A maximum

Circuit Breaker w/ METAL Cover

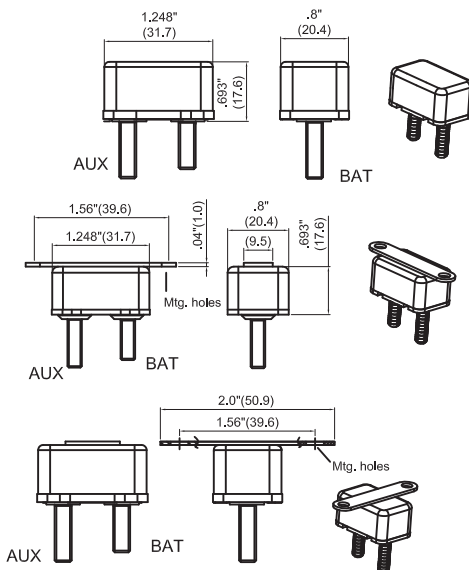

Circuit Breaker w/ PLASTIC Cover

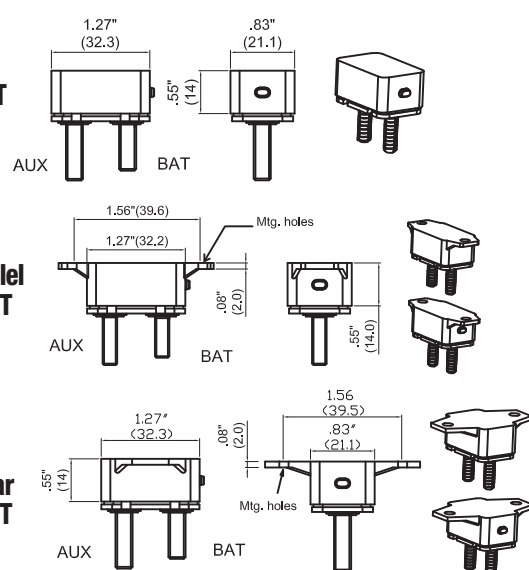

SPECIFICATIONS: Single-Pole Thermal Type Breakers

Rating: 5-50A, 14VDC, 28VDC (for Type II & Type III)

Interrupt Rating (Branch Circuit Protection): 2.5KA @ 12 VDC (Type I & Type I-28VDC, Sealed & Type III)

Operating Temperature: -40°F (-40°C) to 185°F (85°C)

Storage Temperature: -40°F (-40°C) to 260°F (125°C)

Materials: Black UL Rated Thermoplastic Body (Thermo set for Type II Body & Button); Cover is Gray Thermoplastic or Steel, Type I-Gold, Type II-Silver

Terminal: #10-32 Thread and Quick-Connector Available

Torque: 24 in-lbs (2.7 Nm) max

Mounting Torque: Plastic cover: 15 in-lbs (1.7 Nm); Metal cover: 30 in-lbs (3.4 Nm)

Ingress Protection: IP66 On plastic cover version only (except for terminals)

Compliances: SAE J553; SAE J1171 (Consult factory for Ignition Protection Rating)



CIRCUIT BREAKERS

SERIES TYPE I (12VDC) - PLASTIC - AUTO RESET

ITEM #	TERMINAL	RATING	BRACKET	MOUNTING HOLE DIA. Inches	CASE QTY
112A50-A2P	Two 10-32 studs; 0.66" (AUX); 0.56" (Bat)	50 AMP	A	0.196	300
112A50-B5P	Two 10-32 studs; 0.66" (AUX); 0.56" (Bat)	50 AMP	B	0.228	300
112A50-00P	Two 10-32 studs; 0.66" (AUX); 0.56" (Bat)	50 AMP	N/A	N/A	300
112A40-B5P	Two 10-32 studs; 0.66" (AUX); 0.56" (Bat)	40 AMP	B	0.228	300
112A30-A4P	Two 10-32 studs; 0.66" (AUX); 0.56" (Bat)	30 AMP	A	0.265	300
112A30-A6M	Two 10-32 studs; 0.66" (AUX); 0.56" (Bat)	30 AMP	A	0.221	300
112A30-B5P	Two 10-32 studs; 0.66" (AUX); 0.56" (Bat)	30 AMP	B	0.228	300
112A30-00P	Two 10-32 studs; 0.66" (AUX); 0.56" (Bat)	30 AMP	N/A	N/A	300
112L30-A6M	Two 10-32 studs; 0.37" (AUX & Bat)	30 AMP	A	0.221	300
112B25-A5P	Two 10-32 studs; 0.56" (AUX and Bat)	25 AMP	A	0.228	300
112A25-B5P	Two 10-32 studs; 0.66" (AUX); 0.56" (Bat)	25 AMP	B	0.228	300
112A20-B5P	Two 10-32 studs; 0.66" (AUX); 0.56" (Bat)	20 AMP	B	0.228	300
112A20-00P	Two 10-32 studs; 0.66" (AUX); 0.56" (Bat)	20 AMP	N/A	N/A	300
112A15-B5P	Two 10-32 studs; 0.66" (AUX); 0.56" (Bat)	15 AMP	B	0.228	300
112A15-00P	Two 10-32 studs; 0.66" (AUX); 0.56" (Bat)	15 AMP	N/A	N/A	300
112A10-B4P	Two 10-32 studs; 0.66" (AUX); 0.56" (Bat)	10 AMP	B	0.265	300
112A10-00P	Two 10-32 studs; 0.66" (AUX); 0.56" (Bat)	10 AMP	N/A	N/A	300
112A08-B2P	Two 10-32 studs; 0.66" (AUX); 0.56" (Bat)	8 AMP	B	0.196	300
112A06-B5P	Two 10-32 studs; 0.66" (AUX); 0.56" (Bat)	6 AMP	B	0.228	300
112A05-B4P	Two 10-32 studs; 0.66" (AUX); 0.56" (Bat)	5 AMP	B	0.265	300
112A05-B5P	Two 10-32 studs; 0.66" (AUX); 0.56" (Bat)	5 AMP	B	0.228	300

Terminal Diagram

Tolerance: +/- 0.5mm

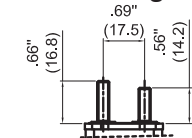

A Two 10-32 studs:
.66"(AUX); .56"(BAT)

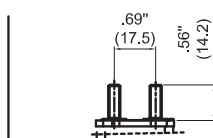

B Two 10-32 studs:
.56"(AUX&BAT)

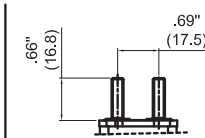

C Two 10-32 studs:
.66"(AUX&BAT)

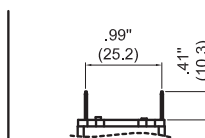

D Two .25" Q.C.
(AUX&BAT)

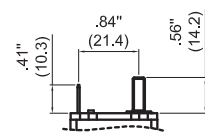

E One .25" Q.C.(AUX);
One 10-32 stud(BAT)

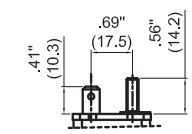

H Double .25" Q.C.(AUX);
One 10-32 stud (BAT)

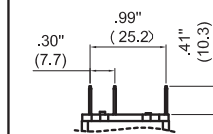

J Double .25" Q.C.(AUX);
Single .25" Q.C. (BAT)

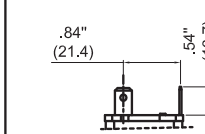

K Two .25" Q.C.(AUX&BAT)
Perpendicular Orientation

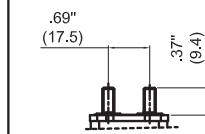

L Two 10-32 studs:
(AUX&BAT)

CIRCUIT BREAKERS

SERIES TYPE II (12VDC) - METAL - MODIFIED RESET*

ITEM #	TERMINAL	RATING	BRACKET	MOUNTING HOLE DIA. Inches	CASE QTY
212A50-A2M	Two 10-32 studs; 0.66" (AUX); 0.56" (Bat)	50 AMP	A	0.196	300
212A50-00M	Two 10-32 studs; 0.66" (AUX); 0.56" (Bat)	50 AMP	N/A	N/A	300
212A40-00M	Two 10-32 studs; 0.66" (AUX); 0.56" (Bat)	40 AMP	N/A	N/A	300
212A30-A3M	Two 10-32 studs; 0.66" (AUX); 0.56" (Bat)	30 AMP	A	0.237	300
212A25-00M-01-WA	Two 10-32 studs; 0.66" (AUX); 0.56" (Bat)	25 AMP	N/A	N/A	300
212A15-00M-01-WB	Two 10-32 studs; 0.66" (AUX); 0.56" (Bat)	15 AMP	N/A	N/A	300
212A15-B3M	Two 10-32 studs; 0.66" (AUX); 0.56" (Bat)	15AMP	B	0.237	300
212D15-00M	Two 0.250" Quick Connect Tabs; (AUX & Bat)	15 AMP	N/A	N/A	300
212A10-B3M	Two 10-32 studs; 0.66" (AUX); 0.56" (Bat)	10AMP	B	0.237	300

*Reset when powered down after circuit is broken

	100%	150%	200%	300%
Less than 25A	> 1,800 sec	< 600 sec.	5 ~ 40 sec.	2 ~ 8 sec.
Over 30A	> 1,800 sec	< 600 sec.	15 ~ 70 sec.	4 ~ 12 sec.

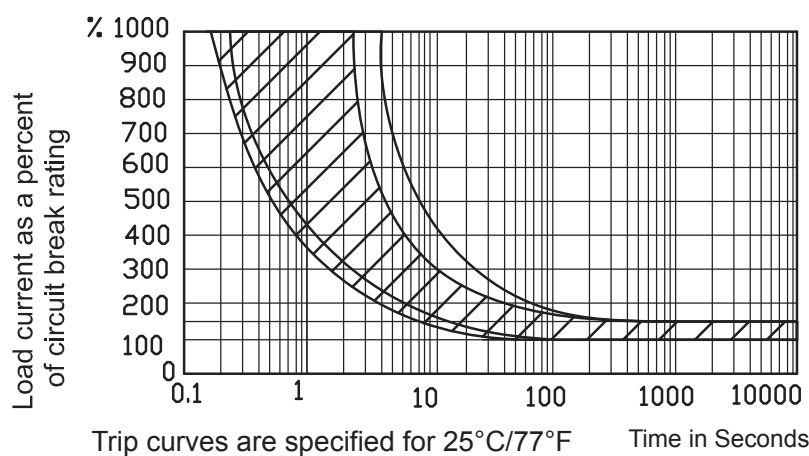

Derating Factor	
0°C	x 1.46
10°C	x 1.35
15°C	x 1.14
18°C	x 1.11
25°C	x 1.00
32°C	x 0.92
40°C	x 0.82
50°C	x 0.70
60°C	x 0.57

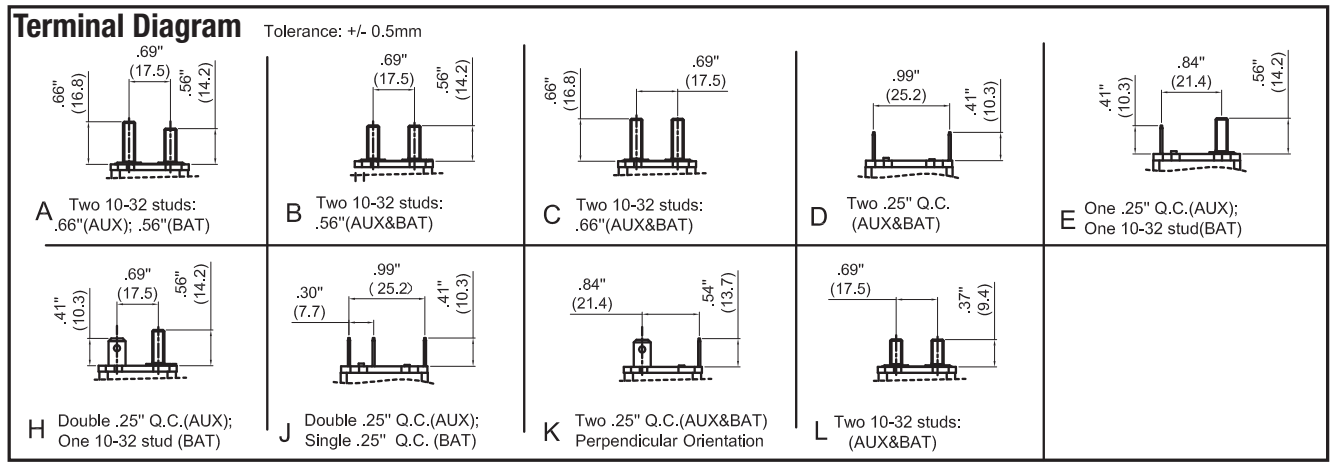

CIRCUIT BREAKERS

SERIES TYPE III (24VDC) - PLASTIC - MANUAL RESET

ITEM #	TERMINAL	RATING	BRACKET	MOUNTING HOLE DIA. Inches	CASE QTY
324A50-A2P	Two 10-32 studs; 0.66" (AUX); 0.56" (Bat)	50 AMP	A	0.196	300
324A50-B5P	Two 10-32 studs; 0.66" (AUX); 0.56" (Bat)	50 AMP	B	0.228	300
324A40-A4P	Two 10-32 studs; 0.66" (AUX); 0.56" (Bat)	40 AMP	A	0.265	300
324A40-B5P	Two 10-32 studs; 0.66" (AUX); 0.56" (Bat)	40 AMP	B	0.228	300
324A30-A4P	Two 10-32 studs; 0.66" (AUX); 0.56" (Bat)	30 AMP	A	0.265	300
324A30-B5P	Two 10-32 studs; 0.66" (AUX); 0.56" (Bat)	30 AMP	B	0.228	300
324A30-00P	Two 10-32 studs; 0.66" (AUX); 0.56" (Bat)	30 AMP	N/A	N/A	300
324A10-B5P	Two 10-32 studs; 0.66" (AUX); 0.56" (Bat)	10 AMP	B	0.228	300

*Manual Reset



TOOLS

TOOLS

Cambridge™ carries a fine set of tools that are commonly found in the electrical, automotive, construction, home improvement, and security industries. Cambridge™ branded tools provide industry-standard instrumental capability, ensuring a complete and optimal working experience.

ITEM #	TOOL	DESCRIPTION	PACKAGING	CASE QTY
TL13712	Digital Multimeter	AC/DC Multimeter w/ overload protection & Low Battery Indicator	Blister	24
TL13713	Soldering Iron	Soldering Iron w/ Stand & 5ft Cord	Clamshell	24
TL13714	Self-Adjusting Crimper/Stripper	For non-insulated 22-10AWG terminals For auto ignition 7-8mm terminals	Heat-Sealed Blister	24
TL13715	Mini Butane Torch	2372°F (1300°C) Butane Torch w/ refillable Fuel Cartridge	Blister	20
TL13716	Crimper/Stripper	9" Spring-loaded Crimper/Stripper	Heat-Sealed Blister	24
TL13717	Electrical Tester	Hi-Lo Voltage Electrical Circuit Tester	Blister	24
TL13721	Fuse Holder	Weatherproof 14GA, Blade-Style Fuse Holder	Clamshell	24

TL13714



TL13713



TL13717



TL13716



TL13715



TL13721



TL13712





QUALITY STANDARDS

Cambridge™ is committed to **raising** the industry standard for **production, precision, and quality.**

Every product manufactured by Cambridge Resources meets or **exceeds industry standards** along with the rigorous **quality control** standards that industrial markets **expect** from Cambridge™.

Our unique **Quality Assurance** and **Quality Control** process includes continuous product testing throughout manufacturing and ensures **comprehensive adherence** to all relevant **code compliances** and **certification requirements.**



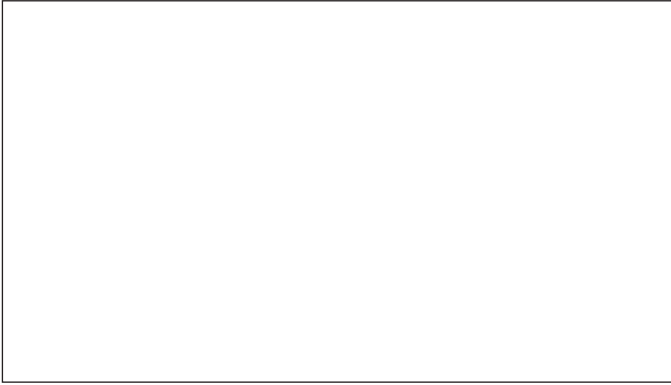

Cambridge Resources

960 Alabama Avenue · Brooklyn, NY 11207

Phone: 718-927-0009

Toll Free: 877-922-2538

Fax: 718-485-4403

www.CambridgeResources.com

info@cambridgeresources.com