

INSTALLATION GUIDE

RESIDENTIAL USE ONLY

Greentek Models	PH 7.15 HRV	(Item No. 463000)
	PH 10.22 HRV	(Item No. 463001)
	PE 7.15 ERV	(Item No. 463007)
	PE 10.22 ERV	(Item No. 463008)

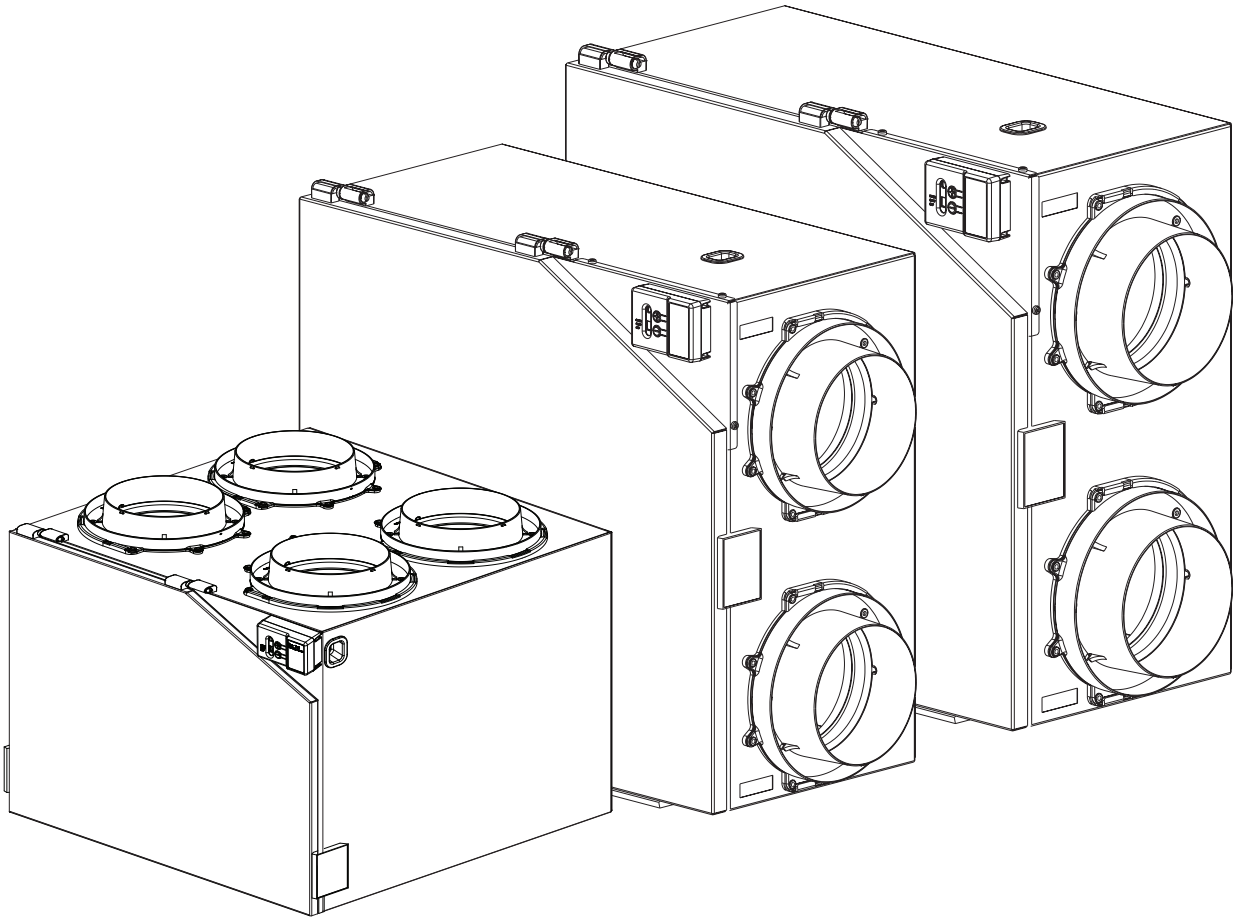

Product of **Greentek**

Greentek reserves the rights to modify a product, without prior notice, whether in price, design, color or codes, in order to offer at all times quality products that are highly competitive.

Greentek

50 Kanalfakt Way, Bouctouche, NB E4S 3M5
1-888-724-5211 Fax 1-866-426-7430
www.Greentek.ca

IMPORTANT - PLEASE READ MANUAL BEFORE INSTALLATION

CAUTION: Do not install in a cooking area or connect directly to any appliance. Turn off all integral disconnects before servicing.

NOTICE: Prior to installing, serious consideration must be taken to insure this ventilation system will operate properly if integrated to any other type of mechanical system, i.e. a forced air system, or an air handling unit. To insure proper operation & compatibilities of both system, it is required that the airflow's of the Heat Recovery Ventilator (HRV) or Energy Recovery Ventilator (ERV) be balanced, by following the procedures found in this manual.

The way that your Heat/Energy-recovery ventilator is installed may make a significant difference to the electrical energy that you will use. To minimize the electricity use of the Heat/Energy-recovery ventilator, a stand-alone fully ducted installation is recommended. If you choose a simplified installation that operates your furnace airhandler for room-to-room ventilation, an electrically efficient furnace that has an electronically commutated (EC) variable speed blower motor will minimize your electrical energy consumption and operating cost.

LIMITATIONS: The product is for residential applications only. Must be installed in accordance with all national and local regulations, building and safety codes.



TO REDUCE OR AVOID THE HAZARDS OF ELECTRIC SHOCK AND FIRE: CAUTIONS CONCERNING THE OPERATION AND FULL EFFICIENCY OF THIS PRODUCT:

- Before servicing or cleaning the HRV system, always remove the power cord from the AC wall outlet.
- To reduce the hazards of electric shock or fire, do not perform any service to the HRV system other than those stated in the operating manual instructions.
- To reduce the risk of electric shock, this ventilation system (HRV/ERV) comes equipped with a 3-prong plug-in. This plug will fit in a polarized outlet only one way.
- Do not use ventilation system for outdoor application.
- Do not pull or twist power cord when disconnecting it from the ventilation system. Grasp the plug firmly, not the cord.
- Do not modify the power plug in any way; if modified, risk of electric shock fire or even damage to the unit may occur.
- Do not use the ventilation system for removal of flammable fumes, gases or connect directly to any appliances.
- Use a dedicated AC 120V outlet only.
- Do not obstruct or cover the air intake or air outlet of the ventilation system.
- Do not modify, repair or disassemble this system. These tasks are to be performed by authorized serviced personnel only. Fire, electrical shock and/or bodily injury may occur if these warnings are not followed.
- To prevent injuries, do not operate the ventilation system, while servicing or maintaining. There are impeller wheels turning at a very high speed that must fully stop rotating prior to accessing the inside of the unit.
- Always assess the operation of the ventilation system on how it may interact with vented combustion equipment (ie. Gas Furnace, Oil Furnace, Combustion, Appliances, etc.)
- Do not use for swimming pool/spa applications.

CONTENTS

SECTION	PAGE
1. Ventilation requirements3
2. Fitting equivalent lengths4
3. Types of Installations5
4. Installation Kit.6
5. Finding a suitable installation area for HRV or ERV.6
6. Installation of the HRV / ERV7
7. Insulated Flex from Unit to Outside Wall7
8. Motorized Damper Assembly (model DH only).8
9. Condensation Drain Line8
10. Dedicated Electric Receptacle8
11. Outside Fresh Air and Exhaust Air Hoods9
12. Benefits of the Duotrol™ System.9
13. Balancing the unit.10
14. Controls Connection12
15. Wiring Diagrams for furnace interlock systems13
16. Troubleshooting14
17. Maintenance15

1. VENTILATION REQUIREMENTS

DETERMINE YOUR VENTILATION NEEDS INSTALLATION

How much fresh air do I need? Good air quality is based in part on the capacity of the home's ventilation system.

Usually, the HRV's/ERV's capacity is measured in CFM (Cubic Feet per Minutes) or L/s (Liters per Seconds) of fresh air being distributed in the living space. The Room Count Calculation or the Air Change per Hour Method shows you how to determine your ventilation needs. (see chart on right)

A. Room Count Calculation

LIVING SPACE	NUMBER OF ROOMS	CFM (L/S)		CFM REQUIRED
Master Bedroom	_____	x 20 cfm (10 L/s)	=	_____
With Basement	_____	x 20 cfm (10 L/s)	=	_____
Single Bedroom	_____	x 10 cfm (5 L/s)	=	_____
Living Room	_____	x 10 cfm (5 L/s)	=	_____
Dinning Room	_____	x 10 cfm (5 L/s)	=	_____
Family Room	_____	x 10 cfm (5 L/s)	=	_____
Recreation Room	_____	x 10 cfm (5 L/s)	=	_____
Other	_____	x 10 cfm (5 L/s)	=	_____
Kitchen	_____	x 10 cfm (5 L/s)	=	_____
Bathroom	_____	x 10 cfm (5 L/s)	=	_____
Laundry Room	_____	x 10 cfm (5 L/s)	=	_____
Utility Room	_____	x 10 cfm (5 L/s)	=	_____
TOTAL ventilation requirement (add last column) =				_____
				1 CFM = 0.47189 L/s 1 L/s = 3.6 m3/hr

B. Air Change per Hour Method

TOTAL cu ft X 0.35 per hr = total
Take total and divide by 60 to get CFM

Example: A 25'x 40' house with basement
 1,000 Sq. ft. x 8' high x 2(1st floor + basement) = 16,000 cu. ft.
 16,000 cu. ft. x 0.35 ACH = 5,600 cu. ft.
 5,600 cu. ft. / 60 Minutes = 93.3 CFM
93.3 CFM IS YOUR VENTILATION NEED

2. FITTING EQUIVALENT LENGTHS

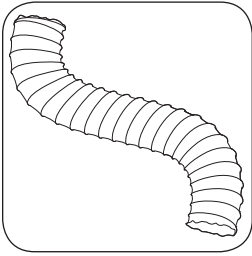

- Flex pipe equivalent length is smooth pipe x2
- Flex fitting equivalent length is smooth fitting x2

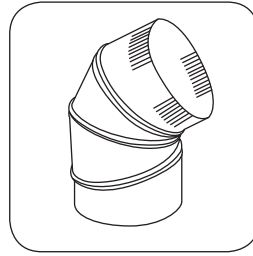

- 45° perimeter pipe elbow equivalent length = 5 ft. (1.52 m)
- NOTE:** Where flex duct is used to make 45° elbow equivalent length = 10 ft. (3.0 m)

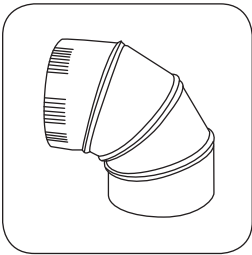

- 90° perimeter pipe elbow equivalent length = 10 ft. (3.0 m)
- NOTE:** Where flex duct is used to make 90° elbow equivalent length = 20 ft. (6.1 m)

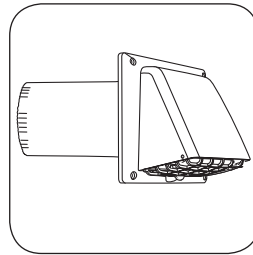

- Round wall cap spring damper or screen equivalent lengths = 60 ft. (18.29 m)

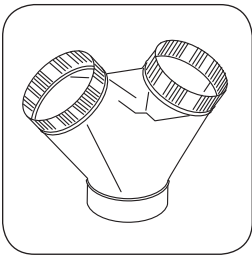

- Y-equal sides equivalent length = 10 ft. (3.0 m)

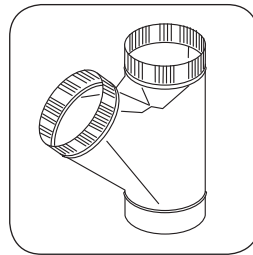

- Y-Side branch equivalent length = 35 ft. (10.7 m)

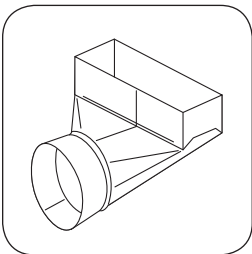

- Angle boot equivalent length = 30 ft. (9.14 m)

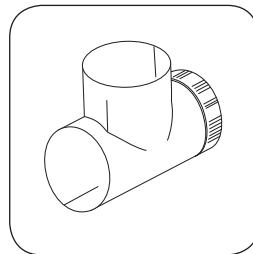

- Tee take-off equivalent length = 50 ft. (15.24 m)

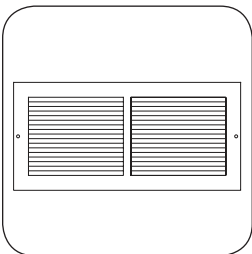

- Wall grill 50% free area equivalent length = 15 ft. (4.6 m)

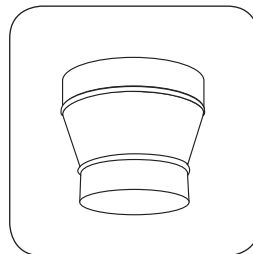

- Increaser/Reducer equivalent length = 8 ft. (2.43 m)

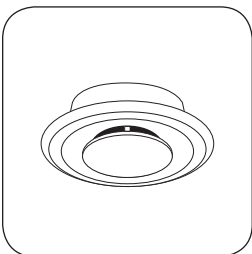

- Round plastic diffuser equivalent length = 100 ft. (30.5 m)
- NOTE:** Maximum airflow assumes diffuser is in full open position.

3. TYPES OF INSTALLATIONS

DIRECT DUCTED SYSTEM

figure 3.1

This application uses a devoted duct system for the supply and the exhausting of stale air accumulated in the home.

It is recommended to install fresh air grilles in all bedrooms and living areas. Exhaust the stale air from the bathroom, kitchen and laundry room. (see figure 3.1)

IMPORTANT: For optimal performance of your HRV or ERV, the installation of an optional 6" round galvanized backdraft damper is required on the fresh air to home duct work.

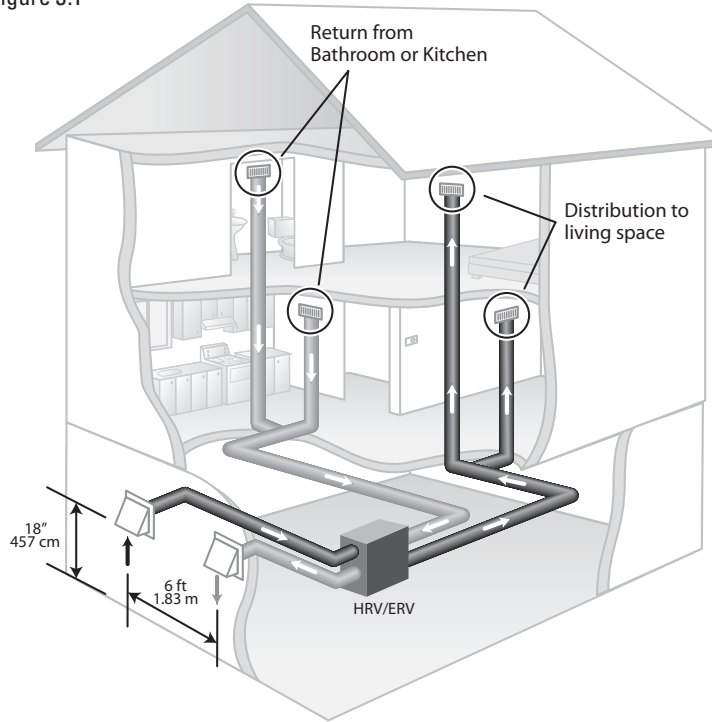

EXTENDED EXHAUST SYSTEM

figure 3.2

This application uses a devoted duct system for the exhausting of stale air accumulated in the home. The fresh air is dumped into the return air duct and is distributed thru the home by the existing supply air ductwork of the forced air system. (see figure 3.2)

Make sure when using this application that your fresh air duct connection to the forced air system return air duct is not less than 10ft (3 m) upstream of the return plenum connection to the forced air system. Check with your local code or the forced air system's manufacturer. The HRV and forced air system must be in continuous mode, to achieve maximum comfort and to avoid cross-contamination.

NOTE TO INSTALLER: Dwellings with multiple forced air systems requires one HRV/ERV per system.

Insure the unit runs in conjunction with forced air system (Ref. wiring diagram for furnace interlock)

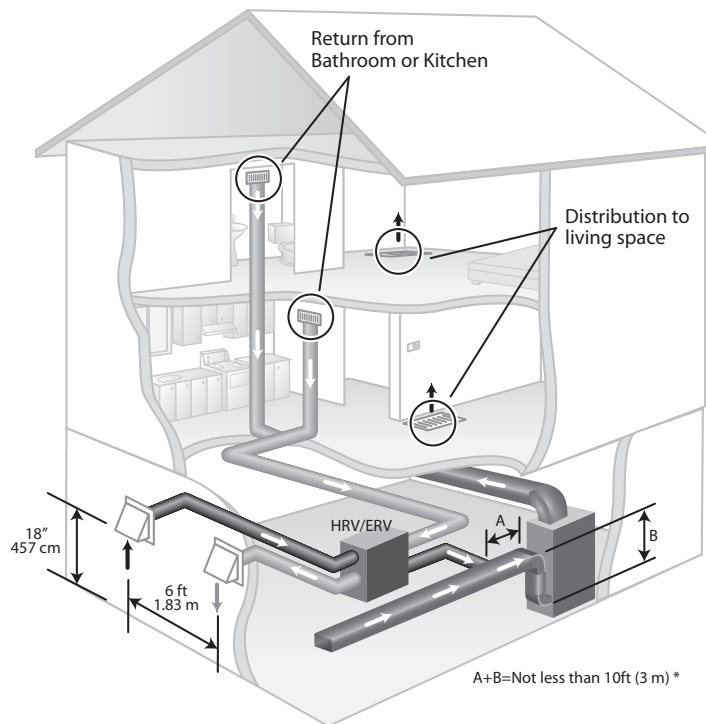

IMPORTANT: The duct bringing outdoor air to the return air plenum must be equipped with a manual damper to balance the outdoor airflow.

* For minimum distance between return and forced air system, check with your local building codes and forced air system manufacturer.

IMPORTANT: For optimal performance of your HRV or ERV, the installation of an optional 6" round galvanized backdraft damper is required on the fresh air to home duct work. When performing duct connections, always use approved tools and material. Also use steel duct connections for these type of installs.

3. TYPES OF INSTALLATIONS (CONTINUED)

SIMPLIFIED SYSTEM INSTALLATION

figure 3.3

When using this application make sure that there is minimum 3 feet (0.9 m) between the fresh air and exhaust air connections of the HRV/ERV in the return air duct. (see figure 3.3)

Make sure when using this application that your fresh air duct connection to the forced air system return air duct is not less than 10ft (3 m) upstream of the return plenum connection to the forced air system. Check with your local code or the forced air system's manufacturer. The HRV and forced air system must be in continuous mode, to achieve maximum comfort and to avoid cross-contamination.

NOTE TO INSTALLER: Dwellings with multiple forced air systems requires one HRV/ERV per system.

Insure the unit runs in conjunction with forced air system (Ref. wiring diagram for furnace interlock)

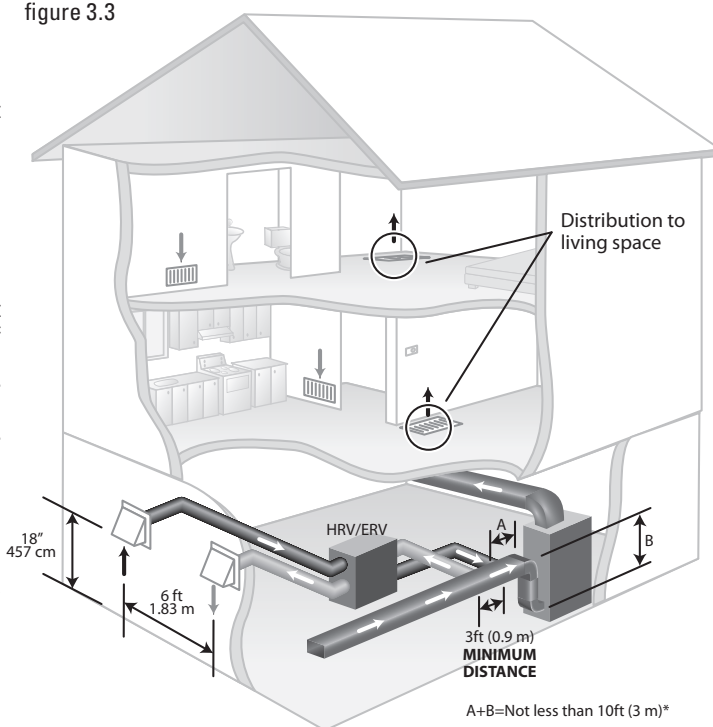

IMPORTANT: The duct bringing outdoor air to the return air plenum must be equipped with a manual damper to balance the outdoor airflow.

*For minimum distance between return and forced air system, check with your local building codes and forced air system manufacturer.

IMPORTANT: For optimal performance of your HRV or ERV, the installation of an optional 6" round galvanized backdraft damper is required on the fresh air to home duct work. When performing duct connections, always use approved tools and material. Also use steel duct connections for these type of installs.

4. INSTALLATION KIT

INSTALLATION KIT INCLUDES:

- 4 Collars
- 2 Flexible Vinyl Ducts for sound attenuation
- 1 Condensation Drain Line
- 1 Drain Adapter with Nut
- 4 Tie Wraps (30")
- 16 screws (#10 x 5/8")
- 4 screws (#10 x 1")
- 4 Washers
- AC 120V power cord

TIP TO INSTALLER: Removing the core unit will facilitate your job.

figure 4.1



5. FINDING A SUITABLE INSTALLATION AREA FOR HRV OR ERV

The HRV/ERV unit should be installed in a mechanical room or as close to an outside wall as possible. This would assure a short run of insulated flexible duct.

The HRV/ERV unit must always be installed in an area where the air is tempered to avoid freezing of the condensate line. The contractor should install the unit in an area that is very accessible to allow the homeowner easy access for maintenance.

It is very important to install an electric receptacle (115v) near the HRV / ERV, a separate circuit breaker is also recommended. You should have access to a condensate drain near the HRV/ERV to avoid the use of condensate pump.

6. INSTALLATION OF THE HRV / ERV

The entire line of Greentek HRV/ERV products is designed for "Single Person Mounting™" (SPM). It will enable you to save time and effort by offering you a variable attachment system and maximizing your basement space.

TIP TO INSTALLER: Place HRV/ERV on a stepladder to ease the hanging process. If the unit is not level, improper drainage will occur and could lead to moisture and leakage problems.

It is recommended to use approximately 16 inches of flexible duct (supplied in kit) between the HRV or ERV and your rigid duct. The flex duct is mounted the same way to the HRV or ERV as the insulated flex.



figure 6.1 Attach your four straps to the floor joist making sure that you attach thru the washers and the grommets.



figure 6.2 Pull on the middle strap and gently push upward on the unit. Then repeat procedure on other side.



figure 6.3 When completing the procedure make sure that the HRV or ERV is leveled.

7. INSULATED FLEX FROM UNIT TO OUTSIDE WALL



WARNING: Always fix and secure the 6" collars with the screws supplied. Avoiding this critical step the unit will accumulate condensation.

TIP TO INSTALLER: To ensure a better installation and to avoid an undesired bend in the duct, align the duct with the collar before securing over the four hooks.

The Fresh air from outside and the Exhaust air to outside from the termination ducts to the HRV/ERV must be fully insulated of thermal insulation ducts to minimize heat loss and gain.

All tapes, mastics, and nonmetallic clamps used for field installation of flexible ducts shall be listed and labeled to Standard UL 181B - Closure Systems for Use With Flexible Air Ducts and Air Connectors.

Air Connector A category of flexible duct not meeting the requirements of an Air Duct per UL 181 Standard (not tested for flame penetration, puncture and impact) and having limitations on use, length and location as defined by NFPA 90A and 90B.

Air Connectors are identified by a "round shape" listing label of the listing agency.

Air Duct A category of flexible duct tested and classified as to the Surface Burning Characteristics in accordance with the UL 181 Standard

Air Ducts are identified by a "rectangular shape" listing label of the listing agency.

To ensure quiet operation of ENERGY STAR qualified HRV/ERVs, each product should be installed using sound attenuation techniques appropriate for the installation. (Ref. Figure 7.5)

IMPORTANT: Always consult your national and local regulations, building and safety codes.



figure 7.1 Insert vinyl duct over the hooks and seal with a Tie wrap.

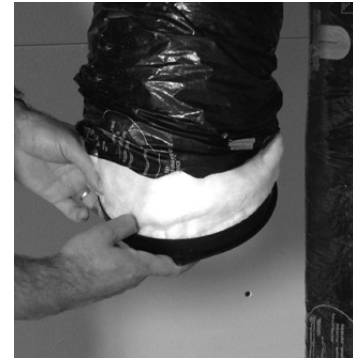

figure 7.2 Insert insulation inside the double collar.



figure 7.3 Finish by taping the vapor barrier to the collar to insure proper seal.



figure 7.4 Slide collar on the unit.

Once insulated flex is attached to the collar, slide collar in keeper section, fixed collar to the unit with four screws supplied in installation kit to insure a proper seal.

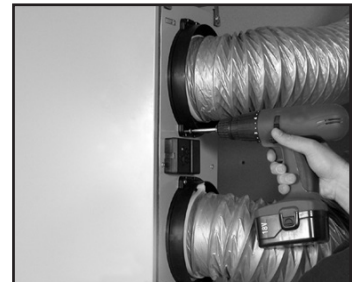

Figure 7.5 Fix and secure with two screws supplied.

8. MOTORIZED DAMPER ASSEMBLY (MODEL DH ONLY)

If you have a model D with the recirculation mode, you can mount your duct to recirculate the air from a cathedral ceiling, or where heated ambient air is available.

The recirculation mode takes already-heated ambient air from a selected area, recirculates it through the unit's filters, and distributes throughout your home.

This option enables the unit to have an auxiliary air supply during the system's defrost period in winter, and offers you better air quality without unpleasant odors.

Some assembly is required on the motorized damper mechanism before operating the unit. Open and remove the recirculation chamber door. Making sure the dampers closes the Fresh Air Port and opens the Recirculation Port, align and secure the assembly bracket to the damper with the screw provided. (see figure 8.1, figure 8.2 & figure 8.3)

The screw is located and tapped into the recirculation chamber. Once assembly is done,

put back the door making sure it is well in place.

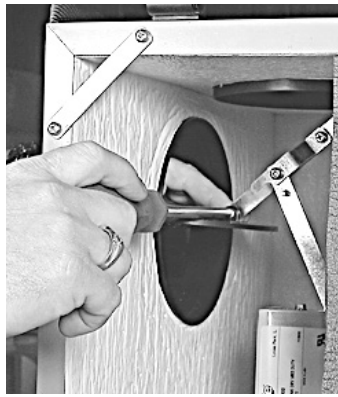

figure 8.1 - Secure the damper with a screw



figure 8.2 - Push on the assembly to release the damper

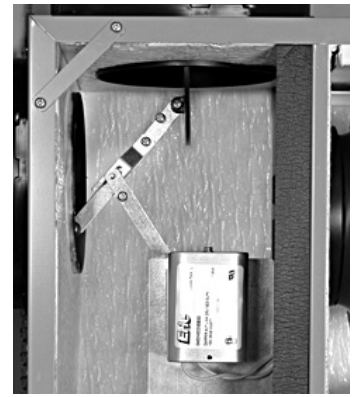
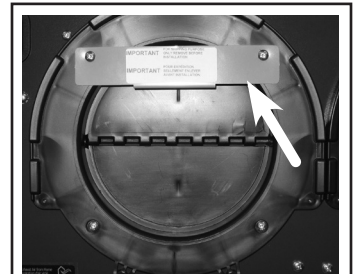

figure 8.3 - Motorized Damper Assembly



WARNING: Never install a stale air or recirculation grill in a closed room containing a combustion device, such as gas furnace, gas water heater fireplace or wood burning stove.



IMPORTANT: You must remove damper bracket before installing unit, SS3.12 DD.

9. CONDENSATION DRAIN LINE

Insert the threaded drain adapter thru the bottom of the HRV/ERV and hand tighten the plastic nut, and with a wrench tighten the nut another half turn to assure a better seal.

Install the condensate line (included in drain kit). Insert condensate tubing by pushing clear plastic line over drain adapter. Make condensate trap by looping the clear plastic tubing. This procedure is to avoid foul odor to enter the HRV or ERV.

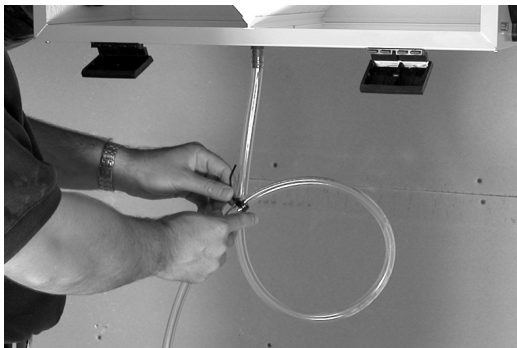

figure 9.1 Make a loop in condensate line, not be subject to freezing temperatures.



figure 9.2 Use a condensate pump if you don't have access to a drain.

10. DEDICATED ELECTRIC RECEPTACLE

IMPORTANT: Always consult a certified technician to insure proper installation of main power.

NOTE: If LED light on the Duotrol remains green, motors not energized controls do not operate. Polarization in main AC outlet are inverted.

It is recommended that the HRV/ERV have a dedicated receptacle with 115v. It is not recommended to connect unit with an extension cord.



figure 10.1 Insert the power cord on top of the unit. Press **firmly** to make sure the power cord is secure.

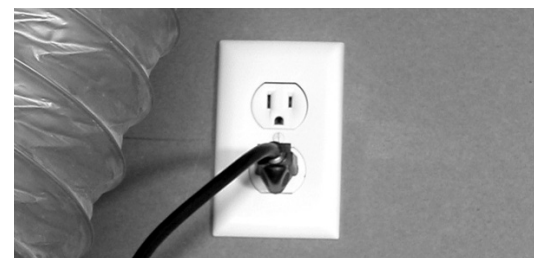

figure 10.2 It is recommended that the HRV or ERV have a dedicated receptacle with 115v. It is not recommended to connect unit with an extension cord. If no receptacle is available please call an electrical contractor and have one installed. Insure polarized is correct

11. OUTSIDE FRESH AIR AND EXHAUST AIR HOODS

TIPTO INSTALLER: We recommend and it is **good practice** to have a minimum of 6ft (1.83 m) between the supply and exhaust vents, unless using a concentric vent design to prevent contamination of intake air.

Always properly seal the supply & exhaust hoods to the exterior of the thermal envelope of the building with caulk or other similar material to inhibit air leakage.

NOTE: Outdoor air intake hoods shall be located to avoid contamination from sources such as:

- Exhaust air openings
- Driveways (auto exhaust)
- Combustion appliances
- Gas meters, oil fill pipes
- Garbage containers
- Attics or crawl spaces
- Under deck or other areas of questionable air quality



figure 11.1 Locating Outside Hoods

IMPORTANT: Always consult your national and local regulations, building and safety codes.

12. BENEFITS OF THE DUOTROL™ SYSTEM

MODE SELECTOR

- Intermittent
- Continuous
- Off

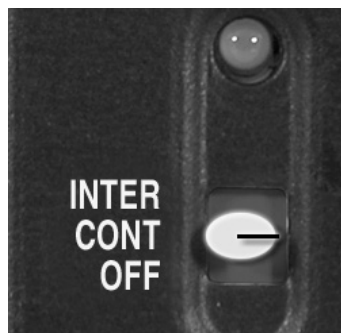

ACTS AS A MODE SELECTOR

INTERMITTENT: When the selector switch is in the intermittent position the HRV/ERV will only run when there is a call for ventilation by any control. At that time the unit will run on high speed until the condition is satisfied.

CONTINUOUS: When the selector switch is in the continuous position the HRV/ERV will run continuously on pre set speed except when there is a call for override by any control.

OFF: When the selector switch is in the off position the HRV/ERV will not come on even if there's a call for ventilation by any control.

SPEED ADJUSTMENT

- Increase Speed (+)
- Decrease Speed (–)



+ BUTTON: Increase the speed of the selected motor.

– BUTTON: Decrease the speed of the selected motor.

13. BALANCING THE UNIT (PH 7.15 & PH 10.22 ONLY)

TOOLS REQUIRED TO BALANCE THE HRV/ERV

- A Magnehelic gauge capable of measuring 0 to 2.0 inch of water (0 to 500 Pa) and two (2) plastic hoses.
- A balancing reference chart located on the HRV/ERV access door panel.

CONSIDERATION WHEN BALANCING THE HRV/ERV

- Seal all the unit ductwork with tape. Close all windows and doors.
- Insure all exhaust devices such as range hood, dryer and bathroom fans are OFF.
- Make sure that all filters are clean and that there is no obstruction in ductwork
- Make sure that the forced air system blower is "ON" when connected to an existing forced air system ductwork.
- If it is a direct duct system installation ensure forced air system blower is "OFF".

USING THE DUOTROL SELECTOR SWITCH

When on Balancing Mode, the Selector Switch allows you to choose the motor you want to set.



GREEN LIGHT Mode Selector

- A) Closed Duotrol Cover
1. INTER (Exhaust Motor)
 2. CONT (Both Motors)
 3. OFF (Supply Motor)



YELLOW LIGHT Balancing Mode

- B) Open Duotrol Cover
1. UP (Exhaust Motor)
 2. MIDDLE (Both Motors)
 3. DOWN (Supply Motor)

IMPORTANT: Insure the HRV/ERV has completed the defrost sequence. That the dehumidistat is deactivated by turning the round dial to the "OFF" position, the Range is "NORMAL", the mode is "CONT" and the Cycle per Hour is set at "0/0".

NOTE: The unit is considered balanced even if there is a difference of ± 10 cfm (or ± 5 l/s or 17 m³/h) between the two air flows

DUOTROL™ BALANCING SYSTEM PROCEDURES

Step 1: Place the Magnehelic gauge on a level surface and adjust the needle to zero.

Step 2: Connect the two (2) plastic hoses to the gauge on the HIGH & LOW pressure connections.

Step 3: Once the total ventilation requirements are determined, you can start balancing the HRV/ERV. (Refer to 1. Ventilation Requirements)

Step 4: Remove the (4) four nylon knock out seals located on the HRV/ERV access door. (Ref fig 13.1)

Fig 13.1

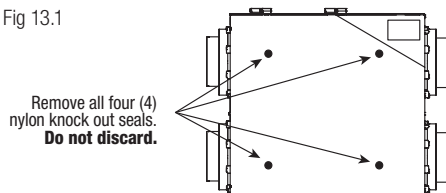

Step 5: Connect the two (2) plastic hoses from the gauge to the HIGH & LOW balancing pressure taps on the fresh or stale air side located on the HRV/ERV access door (Ref Fig 13.2)

Fig 13.2

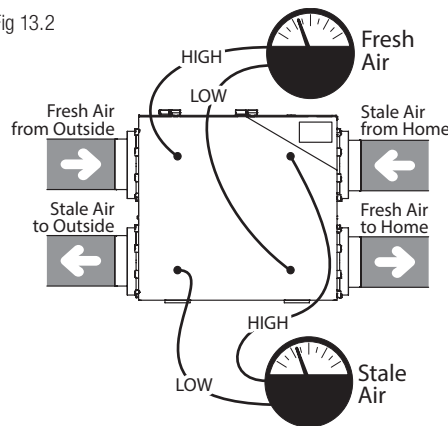

Note: If the gauge needle drops below zero, reverse the plastic hose connections.

PH 7.15 BALANCING CHART

Pressure / Pression		Fresh air / Air frais		Stale air / Air vicié	
IN. W.G.	Pascal (Pa)	CFM PCM	L/s	CFM PCM	L/s
0.60	149	186	88	187	88
0.58	144	182	86	184	87
0.56	139	177	84	180	85
0.54	135	172	81	176	83
0.52	130	167	79	173	82
0.50	125	162	76	169	80
0.48	120	157	74	165	78
0.46	115	152	72	161	76
0.44	110	146	69	156	74
0.42	105	141	67	152	72
0.40	100	136	64	147	69
0.38	95	130	61	143	67
0.36	90	125	59	138	65
0.34	85	119	56	133	63
0.32	80	113	53	128	60
0.30	75	107	50	123	58
0.28	70	102	48	117	55
0.26	65	96	45	112	53
0.24	60	90	42	106	50
0.22	55	84	40	100	47
0.20	50	78	37	94	44
0.18	45	71	34	88	42
0.16	40	65	31	82	39
0.14	35	59	28	76	36
0.12	30	52	25	69	33
0.10	25	46	22	62	29
0.08	20	39	18	56	26
0.06	15	33	16	49	23

Step 6: Press the (+) and (-) buttons on the Duotrol™ simultaneously until you see the yellow light. Once the indicator light turns yellow and the unit goes to high speed you are in balancing mode. When in balancing mode the selector switch on the Duotrol™ becomes the motor selector switch. INTER (Stale Airflow), CONT (Both Motors) and OFF (Fresh Airflow)

Step 7: To adjust the (fresh air), select the «OFF» position on the Duotrol™. Ensure the plastic hoses from the gauge are connected to the HIGH & LOW balancing pressure taps on the fresh airflow side located on the HRV/ERV access door. (Ref Fig 13.2). To adjust the airflow rates, press the (-) button to decrease or press the (+) button to increase the airflow rates until you reach the calculated fresh airflow requirements.

Step 8: To adjust the (stale air) select the «INTER» position on the Duotrol™. Ensure the plastic hoses from the gauge are connected to the HIGH & LOW balancing pressure taps on the stale air side located on the HRV/ERV access door. (Ref Fig 13.2) To adjust the airflow rates, press the (-) button to decrease or press the (+) button to increase the airflow rates until you reach the calculated stale airflow requirements.

Step 9: Once this is completed, you have balanced the airflow rates of your HRV/ERV. To exit the balancing mode you must press (+) and (-) buttons on the Duotrol™ simultaneously until solid green LED appears then release. The indicator light will turn green to indicate normal operation mode. Seal the (4) four balancing pressure taps with the nylon knock out seals removed in Step 4.

Step 10: Mark down the balanced air flow rates information on a label including in the kit. Apply the label to the HRV/ERV access door for future reference (e.g. date, balance airflow rate, your name, phone number and business address).

Note: Once the HRV/ERV is balanced, switch to «CONT» on the Duotrol™ By using (+) and (-) buttons you can set the continuous speed.

PH 10.22 BALANCING CHART

Pressure / Pression		Fresh air / Air frais		Stale air / Air vicié	
IN. W.G.	Pascal (Pa)	CFM PCM	L/s	CFM PCM	L/s
0.36	90	216	102	-	-
0.34	85	209	99	222	105
0.32	80	200	94	214	101
0.30	75	192	91	207	98
0.28	70	183	86	198	93
0.26	65	173	82	189	89
0.24	60	163	77	180	85
0.22	55	153	72	170	80
0.20	50	142	67	159	75
0.18	45	131	62	148	70
0.16	40	119	56	136	64
0.14	35	107	50	124	59
0.12	30	95	45	111	52
0.10	25	82	39	97	46
0.08	20	68	32	83	39
0.06	15	55	26	69	33
0.04	10	55	26	54	25

IMPORTANT: THE BALANCING CHART IS LOCATED ON THE HRV/ERV ACCESS DOOR

13. BALANCING THE UNIT (WITH BALANCING AIRFLOW GRID)

WITH THE DUOTROL™ SYSTEM



GREEN LIGHT
MODE SELECTOR



YELLOW LIGHT
BALANCING MODE

USING THE SELECTOR SWITCH

TIP TO INSTALLER: When on Balancing Mode, the Selector Switch allows you to choose the motor you want to set.

A) CLOSED DUOTROL COVER

1. **INTER** (Exhaust Motor)
2. **CONT** (Both Motors)
3. **OFF** (Supply Motor)

B) OPEN DUOTROL COVER

1. **UP** (Exhaust Motor)
2. **MIDDLE** (Both Motors)
3. **DOWN** (Supply Motor)

DUOTROL™ BALANCING SYSTEM PROCEDURES, STEPS 1 THROUGH 8.

Step 1: Press the (+) and (-) buttons simultaneously until you see the yellow light. Once the indicator light turns yellow you are in balancing mode.

Step 2: When in balancing mode the selector switch becomes the motor selector switch. INTER (Right Motor), CONT (Both Motors) and OFF (Left Motor)

Step 3: Once the total cfm needed is determined, you can start balancing the HRV/ERV. Set your fresh air supply by selecting the «OFF» position on the Duotrol™. Install your magnehelic gauge and air flow grid in the fresh air duct.

Step 4: Press the (-) button to decrease the cfm or press the (+) button to increase the cfm.

Step 5: Then perform the same operation on the stale air side by selecting the «INTER» position on the Duotrol™.

Step 6: The «CONT» position will allow you to adjust the cfm on both motors proportionately (if necessary).

Step 7: Once this is completed, you have set the high speed on your HRV/ERV. To exit the balancing mode you must press (+) and (-) buttons simultaneously and release. The indicator light will turn green to indicate normal operation mode.

Step 8: Once high speed is set and locked, switch to continuous on the Duotrol™. By using (+) and (-) buttons set continuous speed.

WITH AN AIRFLOW GRID & MAGNEHELIC GAUGE

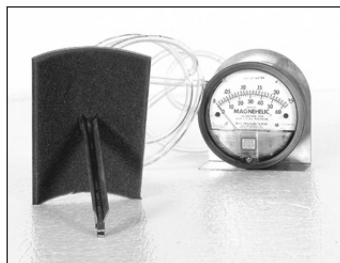

Magnehelic Gauge with Air Flow Grid



Inserting Air flow grid in duct



Seal Air flow grid in duct with duct tape.

14. CONTROLS CONNECTION

VECTRA SERIES - MODEL EHC 1.0 & EHC 1.5 (4 WIRES)

Installation of a Vectra Series main wall control with your HRV/ERV will improve comfort and may significantly reduce the product's energy use.

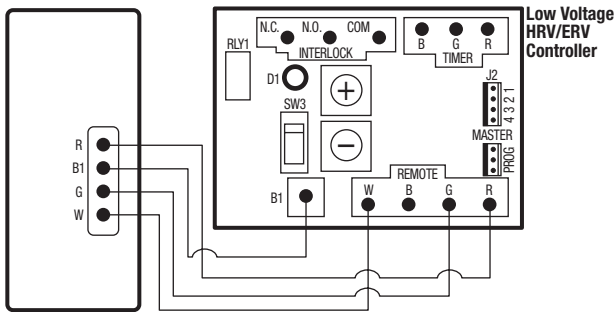

RD-1 (2 WIRES)

Installation of a RD-1 main wall control with your HRV/ERV will improve comfort and may significantly reduce the product's energy use.

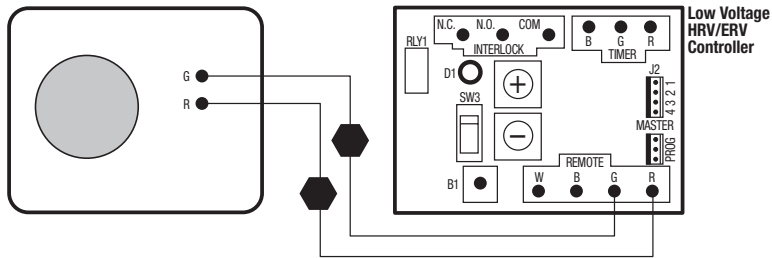

RD-2, RD-3P, RD-4P (4 WIRES)

Installation of a RD-Series main wall control with your HRV/ERV will improve comfort and may significantly reduce the product's energy use.

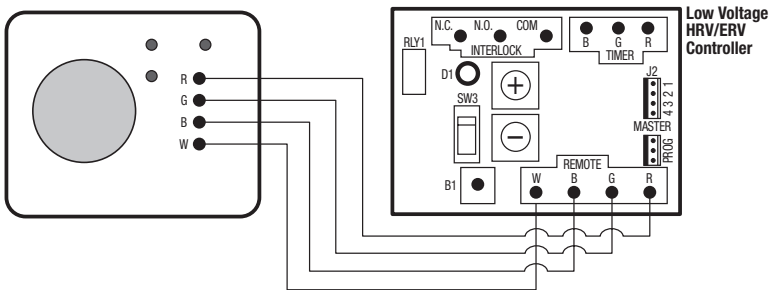

T3 TIMER (3 WIRES)

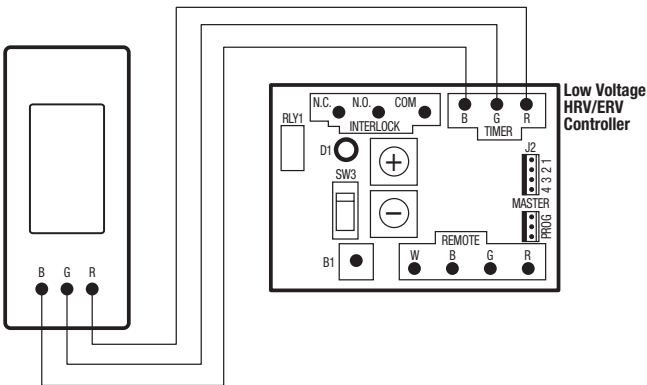

CAUTION: Minimum wire requirements is LVT18 CSA/UL 4 strain to insure proper connection.

15. WIRING DIAGRAMS FOR FURNACE INTERLOCK SYSTEMS

STANDARD FORCED AIR INTERLOCKING WIRING

A relay is normally used when tying a ventilation system to the forced air distribution system. Our Duotrol System is equipped with an internal relay that will activate the forced air system' ventilator when there is a demand from the HRV /ERV. The Duotrol System will activate the INTERLOCK relay during the following modes: Continuous, Override, Recirculation and Defrost. See wiring diagram.

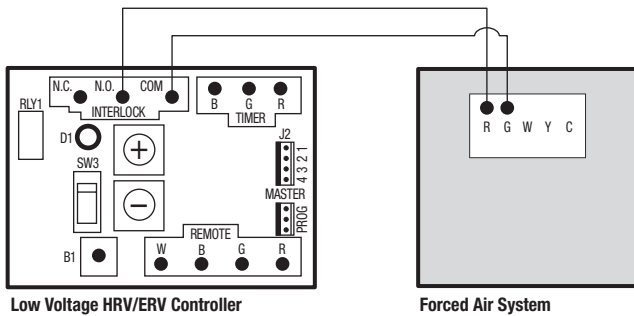

ALTERNATE FORCED AIR INTERLOCKING WIRING

Some forced air system thermostat will activate the cooling system when tied using the «Standard forced air interlocking wiring». If you have identify this type of thermostat you must proceed with the «Alternate Forced Air Wiring».

Locating the Wiring Diagram

Note to installer: Wiring Diagram for the entire line of HRV/ERV Models are placed on the back of each Exhaust motor bracket.

CAUTION: Thermostat that control A/C system must use the Alternate Interlock Wiring Diagram.

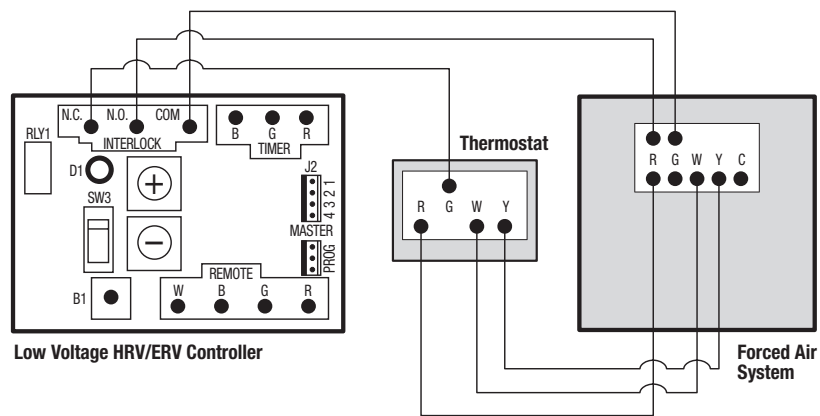

Standard forced air wiring diagram

**Before tying the HRV/ERV to a forced air system, always refer to system's manual or manufacturer.*



WARNING: Always disconnect the unit prior to making any connections. Failure to disconnecting the power could result in electrical shock or can damage the electronic boards, wall controls and/or unit.

CAUTION: Minimum wire requirements is LVT18 CSA/UL 4 strain to insure proper connection.

16. TROUBLESHOOTING

QUESTION / ITEM	DIAGNOSIS / SOLUTION
<ul style="list-style-type: none"> • HRV/ERV not running 	<ul style="list-style-type: none"> • Verify breaker in main electrical panel • Verify the HRV or ERV is in the ON position • Verify the all wall controls switch on the HRV or ERV are activated to supply power to the unit • Unplug HRV or ERV verify if the controller is wired correctly to the connection box on the side of the unit • Verify main outlet polarization
<ul style="list-style-type: none"> • Air is too dry 	<ul style="list-style-type: none"> • Reduce the humidity level on the controller • Reduce continuous airflow rate • Switch ventilation mode from continuous to intermittent • Humidifier recommended if heating source is a forced air system
<ul style="list-style-type: none"> • Air too humid 	<ul style="list-style-type: none"> • Suggest continuous operation of HRV or ERV • Increase humidity level on dehumidistat • Increase continuous airflow rate • Insufficient ventilation, check capacity • Internal source of moisture, e.g. heating wood store in basement, possible leaks or poor insulation R-value and or dryer is venting in basement
<ul style="list-style-type: none"> • Vibration or noise 	<ul style="list-style-type: none"> • Verify that vibration mounting straps, hanging chains or wall bracket is used for hanging the units. • Verify that flexible duct connections are use between the HRV or ERV and the rigid duct. • Verify that the motors are operating and are not obscured by any debris • Insure motor moves freely with turning by hand.
<ul style="list-style-type: none"> • Cold air 	<ul style="list-style-type: none"> • Misplaced supply outlets • Defrost no operating correctly • The HRV or ERV not properly balanced • High airflow on furnace continuous mode • Insure HRV or ERV is interlock when integrated with forced air system
<ul style="list-style-type: none"> • Contamination or Pollutants 	<ul style="list-style-type: none"> • Insure proper clearance of ventilation hoods from source of contaminants Refer to section 10. Outside Fresh Air and Exhaust Air Hoods.
<ul style="list-style-type: none"> • Condensation 	<ul style="list-style-type: none"> • Verify that the HRV or ERV is level to insure proper drainage • Verify that the duct connection are fix and secured with screws to the HRV or ERV. • Verify the cold side duct connections are fully insulated and that vapor barrier is taped to insure a proper seal. • Look for signs of crushed section, failing duct straps, puncture vapor barrier, missing insulation. • Insure proper seal of vapor barrier to outside wall. • Look for sign of water accumulation/leakage/dripping • Verify that the drain connection is not kinked; the "P" trap is not to close to unit or obscured with debris.

17. MAINTENANCE

ROUTINE MAINTENANCE

SEVEN-STEP MAINTENANCE SCHEDULE

With routine preventative maintenance, you can avoid unnecessary problems, ensure the effectiveness of your HRV, and prolong its life. For additional specific instructions, refer to your HRV operating manual or ask the contractor who installed or services the HRV to demonstrate the proper maintenance procedures.



WARNING:
BE SURE TO DISCONNECT THE ELECTRICAL POWER BEFORE SERVICING YOUR SYSTEM

1. Clean or replace air filters. Filters, which are located within the HRV should be cleaned every two to three months. Filters should be vacuumed first, then washed with a mild soap and water. Most washable filters will last several years before needing to be replaced.
2. Clean the exterior intake and exhaust vents of obstructions. Check the outside vents regularly to ensure that the screen openings are not obstructed by grass, bushes, leaves, snow or other debris.
3. Clean and inspect the heat-exchange core and aluminum louvers (*Ref. Fig. 17.1 for proper orientation of louvers*). Twice a year and clean it as required (consult your owner's manual for instructions on inspecting and cleaning the core). A build-up of dust and dirt can restrict airflow and reduce the efficiency of your HRV/ERV. After inspection and cleaning, make sure the core is replaced right-side-up.
4. Clean the condensate drain and pan. Twice a year, check the condensate drain and tubing to ensure that they are open and free-flowing. The tubing can be disconnected for cleaning. The condensate drain must have a "trap" in the tubing that traps a quantity of water – to prevent air from entering the HRV/ERV via this tubing
5. Service the fans. The fans on the HRV/ERV's are designed to operate continuously without lubrication. Inspect the blower fans periodically for dirt on the blades, and remove it by gently brushing the blades or using a vacuum cleaner.
6. Clean the grilles and inspect the ductwork. Clean the grilles when they are dusty. At least once a year, visually inspect the ductwork leading to and from the HRV. Damaged ducts can lead to condensation problems, including wet insulation, water on the floor and, ice build-up. If the insulation itself is damaged.
7. Arrange for an annual servicing. Your HRV/ERV should undergo annual general servicing by a certified contractor and who is familiar with your HRV. If possible, have your furnace and HRV serviced at the same time; this will result in less inconvenience and cost than two separate visits.

Greentek products are backed by the best limited warranty on the market.

Greentek reserves the rights to modify a product, without prior notice, whether in price, design, color or codes, in order to offer at all times quality products that are highly competitive.

ALWAYS CONSULT YOUR NATIONAL AND LOCAL REGULATIONS BUILDING AND SAFETY CODES.



50 Kanalfakt Way., Bouctouche, NB E4S 3M5

1-888-724-5211 Fax 1-866-426-7430

www.greentek.ca